

RUND UM DEN KAMIN



FIREPLACE TOOLS

Kaminbestecke

ACCESSOIRES DE CHEMINEE



LIENBACHER

KAM
iN ZUBE
HÖR



LIENBACHER

Rund um den Kamin - Inhalt

KAM IN ZUBE HÖR

	21.02.146.2	39	21.02.294.2	76	21.02.484.2	35	21.02.735.2	44	
	21.02.147.2	71	21.02.298.2	76	21.02.485.2	35	21.02.736.2	43	
	21.02.148.2	71	21.02.299.2	26	21.02.531.2	23	21.02.738.2	59	
	21.02.152.2	21	21.02.307.2	12	21.02.535.2	44	21.02.739.2	48	
	21.02.153.2	29	21.02.317.2	6	21.02.539.2	48	21.02.740.2	46	
	21.02.170.2	77	21.02.318.2	6	21.02.540.2	52	21.02.741.2	51	
	21.02.171.2	77	21.02.319.2	6	21.02.542.2	57	21.02.743.2	53	
	21.02.172.2	77	21.02.322.2	15	21.02.554.2	62	21.02.744.2	46	
	21.02.174.2	77	21.02.327.2	12	21.02.555.2	62	21.02.751.22	49	
	21.02.175.2	77	21.02.330.2	28	21.02.556.2	62	21.02.752.2	30	
	21.02.176.2	77	21.02.331.2	28	21.02.557.2	62	21.02.755.2	31	
	21.02.177.2	77	21.02.333.2	16	21.02.559.2	62	21.02.756.2	59	
	21.02.178.2	77	21.02.342.2	20	21.02.560.2	62	21.02.757.2	46	
	21.02.179.2	77	21.02.343.2	16	21.02.561.2	62	21.02.759.2	30	
	21.02.180.2	76	21.02.344.2	45	21.02.562.2	62	21.02.762.2	30	
	21.02.181.2	76	21.02.344.LED	45	21.02.563.2	63	21.02.763.2	43	
0745178398688	73	21.00.410.0	95	21.02.346.2	20	21.02.564.2	63	21.02.764.2	30
0745178398695	73	21.00.410.1	95	21.02.347.2	9	21.02.565.2	63	21.02.766.2	31
20.00.110.0	84	21.00.411.0	95	21.02.348.2	8	21.02.566.2	63	21.02.767.2	30
20.00.110.1	84	21.00.411.1	95	21.02.350.2	71	21.02.567.2	63	21.02.769.2	32
20.00.110.2	84	21.00.480.2	72	21.02.353.2	71	21.02.568.2	63	21.02.791.22	49
20.00.112.0	84	21.00.481.2	72	21.02.364.2	63	21.02.569.2	63	21.02.792.22	49
20.00.113.0	84	21.00.485.2	72	21.02.365.2	63	21.02.570.2	63	21.02.800.0	88
20.00.114.0	84	21.00.486.2	72	21.02.366.2	63	21.02.571.2	64	21.02.801.0	88
20.00.115.0	84	21.00.600.2	80	21.02.368.2	63	21.02.572.2	64	21.02.802.0	88
20.00.116.0	84	21.00.602.2	80	21.02.371.2	25	21.02.577.2	64	21.02.810.0	97
20.03.950.0	95	21.00.603.2	80	21.02.374.2	22	21.02.578.2	64	21.02.811.0	97
20.03.960.0	95	21.00.604.2	80	21.02.375.2	22	21.02.579.2	64	21.02.812.0	97
21.00.202.2	46	21.00.608.2	80	21.02.376.2	19	21.02.599.2	26	21.02.820.2	64
21.00.207.2	35	21.00.609.2	80	21.02.204.2	14	21.02.377.2	19	21.02.821.2	64
21.00.208.2	59	21.00.610.2	79	21.02.205.2	44	21.02.378.2	22	21.02.824.2	64
21.00.209.2	57	21.00.611.2	79	21.02.206.2	42	21.02.379.2	19	21.02.825.2	33
21.00.223.2	58	21.00.612.2	79	21.02.208.2	27	21.02.380.2	76	21.02.830.2	54
21.00.225.2	29	21.00.615.0	79	21.02.209.2	14	21.02.381.2	76	21.02.831.2	54
21.00.228.2	58	21.00.625.2	81	21.02.219.2	15	21.02.382.2	76	21.02.832.2	54
21.00.240.2	38	21.00.628.2	81	21.02.220.2	24	21.02.383.2	76	21.02.834.2	54
21.00.242.2	38	21.00.800.2	93	21.02.226.2	17	21.02.384.2	76	21.02.836.2	54
21.00.244.2	39	21.00.805.2	93	21.02.227.2	16	21.02.385.2	76	21.02.844.2	45
21.00.257.2	41	21.00.810.2	93	21.02.228.2	16	21.02.386.2	76	21.02.851.2	77
21.00.258.2	40	21.00.811.2	93	21.02.230.2	23	21.02.387.2	76	21.02.852.2	77
21.00.259.2	40	21.00.812.2	93	21.02.231.2	23	21.02.388.2	76	21.02.853.2	77
21.00.260.2	38	21.00.813.2	93	21.02.237.2	22	21.02.389.2	76	21.02.860.2	75
21.00.261.2	38	21.00.814.2	93	21.02.243.2	51	21.02.393.2	76	21.02.860.OF	75
21.00.262.2	43	21.00.815.2	93	21.02.246.2	62	21.02.394.2	76	21.02.862.2	75
21.00.263.2	29	21.00.818.2	93	21.02.247.2	62	21.02.396.2	77	21.02.862.2	75
21.00.264.2	27	21.00.820.2	94	21.02.248.2	62	21.02.397.2	77	21.02.863.2	75
21.00.270.2	36	21.00.821.2	94	21.02.249.2	62	21.02.398.2	76	21.02.864.2	75
21.00.271.2	33	21.00.822.2	94	21.02.250.2	62	21.02.399.2	26	21.02.864.OF	75
21.00.272.2	33	21.00.823.2	94	21.02.251.2	62	21.02.414.2	24	21.02.865.2	75
21.00.273.2	31	21.00.825.2	94	21.02.252.2	62	21.02.417.2	32	21.02.866.2	75
21.00.274.2	34	21.02.009.2	36	21.02.253.2	62	21.02.419.2	41	21.02.868.2	75
21.00.275.2	34	21.02.010.2	37	21.02.254.2	62	21.02.420.2	41	21.02.869.2	75
21.00.276.2	34	21.02.014.2	37	21.02.255.2	62	21.02.421.2	41	21.02.870.2	77
21.00.277.2	34	21.02.019.2	44	21.02.256.2	62	21.02.422.2	41	21.02.871.2	77
21.00.278.2	30	21.02.020.2	44	21.02.257.2	62	21.02.430.2	28	21.02.872.2	77
21.00.365.2	72	21.02.025.2	35	21.02.259.2	62	21.02.431.2	28	21.02.873.2	75
21.00.366.2	72	21.02.026.2	35	21.02.260.2	62	21.02.434.2	24	21.02.874.2	75
21.00.370.2	64	21.02.027.2	35	21.02.262.2	62	21.02.435.2	61	21.02.875.2	75
21.00.371.2	64	21.02.030.2	37	21.02.263.2	62	21.02.439.2	43	21.02.876.2	75
21.00.372.2	64	21.02.031.2	60	21.02.264.2	62	21.02.440.2	42	21.02.876.OF	75
21.00.373.2	64	21.02.032.2	37	21.02.265.2	24	21.02.441.2	8	21.02.877.2	75
21.00.374.2	72	21.02.034.2	56	21.02.270.2	25	21.02.442.2	20	21.02.878.2	74
21.00.375.2	64	21.02.035.2	57	21.02.271.2	25	21.02.443.2	13	21.02.880.2	74
21.00.381.2	70	21.02.042.2	36	21.02.272.2	26	21.02.444.2	15	21.02.881.2	74
21.00.382.2	69	21.02.043.2	36	21.02.273.2	14	21.02.447.2	21	21.02.882.2	74
21.00.383.2	69	21.02.050.2	35	21.02.280.2	76	21.02.448.2	21	21.02.883.2	74
21.00.400.0	96	21.02.052.2	35	21.02.281.2	76	21.02.449.2	21	21.02.884.2	74
21.00.401.0	96	21.02.110.2	18	21.02.282.2	76	21.02.450.2	42	21.02.885.2	74
21.00.402.0	96	21.02.111.2	18	21.02.283.2	76	21.02.452.2	65	21.02.886.2	74
21.00.403.0	96	21.02.112.2	18	21.02.284.2	76	21.02.453.2	65	21.02.887.2	74
21.00.404.0	96	21.02.125.2	47	21.02.285.2	76	21.02.455.2	40	21.02.888.2	74
21.00.405.0	96	21.02.126.2	17	21.02.286.2	76	21.02.460.2	29	21.02.889.2	74
21.00.406.0	95	21.02.127.2	17	21.02.287.2	76	21.02.462.2	65	21.02.893.2	74
21.00.407.0	95	21.02.128.2	17	21.02.288.2	76	21.02.463.2	65	21.02.894.2	74
21.00.408.0	95	21.02.130.2	47	21.02.289.2	76	21.02.465.2	40	21.02.895.2	74
21.00.409.0	95	21.02.144.2	39	21.02.293.2	76	21.02.466.2	40	21.02.897.2	74

21.02.898.2	74	21.06.008.0	67	21.06.135.0	88	21.06.272.0	86	21.06.348.0	89	21.06.430.0	91
21.02.903.2	36	21.06.015.0	67	21.06.136.0	88	21.06.273.0	86	21.06.349.0	89	21.06.431.0	91
21.02.904.2	32	21.06.019.0	67	21.06.137.0	88	21.06.279.0	88	21.06.354.0	90	21.06.432.0	92
21.02.910.2	62	21.06.030.0	100	21.06.138.0	88	21.06.290.0	87	21.06.355.0	90	21.06.433.0	92
21.02.911.2	62	21.06.031.0	100	21.06.139.0	88	21.06.291.0	87	21.06.356.0	90	21.06.435.0	91
21.02.912.2	62	21.06.041.0	99	21.06.140.0	86	21.06.300.0	89	21.06.357.0	90	21.06.436.0	91
21.02.913.2	62	21.06.042.0	102	21.06.141.0	86	21.06.301.0	89	21.06.358.0	90	21.06.437.0	92
21.02.914.2	62	21.06.043.0	99	21.06.142.0	86	21.06.302.0	89	21.06.359.0	90	21.06.438.0	92
21.02.915.2	62	21.06.045.0	98	21.06.143.0	88	21.06.303.0	89	21.06.367.0	89	21.06.440.0	92
21.02.916.2	63	21.06.048.0	99	21.06.145.0	87	21.06.304.0	89	21.06.368.0	89	21.06.441.0	92
21.02.917.2	63	21.06.049.0	99	21.06.146.0	87	21.06.306.0	89	21.06.369.0	89	21.06.442.0	92
21.02.918.2	63	21.06.051.0	99	21.06.147.0	88	21.06.311.0	89	21.06.370.0	89	21.06.443.0	92
21.02.923.2	9	21.06.054.0	99	21.06.150.0	92	21.06.312.0	89	21.06.371.0	89	21.06.445.0	91
21.02.928.2	12	21.06.062.0	97	21.06.151.0	86	21.06.313.0	89	21.06.372.0	89	21.06.446.0	91
21.02.930.2	7	21.06.063.0	101	21.06.155.0	88	21.06.314.0	89	21.06.373.0	89	21.06.470.0	101
21.02.932.2	19	21.06.072.0	101	21.06.156.0	88	21.06.315.0	89	21.06.374.0	89	21.06.471.0	101
21.02.933.2	19	21.06.073.0	101	21.06.157.0	88	21.06.316.0	89	21.06.375.0	89	21.06.500.0	94
21.02.934.2	10	21.06.075.0	101	21.06.158.0	88	21.06.317.0	89	21.06.376.0	89	21.06.500.7	94
21.02.935.2	10	21.06.077.0	101	21.06.169.0	86	21.06.318.0	89	21.06.378.0	90	21.06.501.0	94
21.02.936.2	11	21.06.080.0	102	21.06.170.0	86	21.06.319.0	89	21.06.379.0	90	21.06.501.7	94
21.02.939.2	5	21.06.081.0	102	21.06.171.0	86	21.06.320.0	90	21.06.400.0	91	21.06.502.0	94
21.02.940.2	5	21.06.082.0	102	21.06.172.0	86	21.06.321.0	90	21.06.401.0	91	21.06.502.7	94
21.02.943.2	13	21.06.083.0	102	21.06.173.0	86	21.06.322.0	90	21.06.402.0	91	21.06.503.0	94
21.02.947.2	9	21.06.084.0	102	21.06.179.0	88	21.06.323.0	89	21.06.403.0	91	21.06.503.7	94
21.02.948.2	9	21.06.088.0	100	21.06.190.0	87	21.06.328.0	90	21.06.404.0	91	21.06.504.0	94
21.02.949.2	19	21.06.090.0	67	21.06.191.0	87	21.06.329.0	90	21.06.405.0	91	21.06.505.0	94
21.02.951.2	33	21.06.091.0	67	21.06.200.0	86	21.06.330.0	90	21.06.406.0	91	21.06.511.0	94
21.02.952.2	32	21.06.091.1	67	21.06.201.0	86	21.06.331.0	90	21.06.407.0	91	21.06.511.7	94
21.02.953.2	33	21.06.091.2	67	21.06.202.0	86	21.06.334.0	90	21.06.408.0	91	21.06.512.0	94
21.02.954.2	11	21.06.091.3	67	21.06.203.0	86	21.06.335.0	90	21.06.409.0	91	21.06.512.7	94
21.02.955.2	11	21.06.091.5	67	21.06.204.0	86	21.06.336.0	90	21.06.410.0	92	21.06.515.0	94
21.02.956.2	7	21.06.091.99	67	21.06.205.0	86	21.06.337.0	90	21.06.411.0	92	21.06.516.0	94
21.02.957.2	7	21.06.093.3	67	21.06.206.0	86	21.06.338.0	90	21.06.412.0	92	21.06.517.0	94
21.02.958.2	5	21.06.093.5	67	21.06.207.0	86	21.06.339.0	90	21.06.413.0	92	21.06.518.0	94
21.02.959.2	5	21.06.094.0	68	21.06.208.0	86	21.06.340.0	90	21.06.420.0	91	21.06.519.0	94
21.02.960.2	78	21.06.094.2	68	21.06.209.0	86	21.06.341.0	89	21.06.421.0	91	21.06.520.0	94
21.02.961.2	78	21.06.095.0	67	21.06.210.0	86	21.06.342.0	89	21.06.422.0	91	21.06.602.0	100
21.02.962.2	75	21.06.096.0	68	21.06.211.0	87	21.06.343.0	89	21.06.423.0	91	21.06.604.0	100
21.02.966.2	21	21.06.096.CH	68	21.06.212.0	87	21.06.344.0	89	21.06.424.0	91	30.60.025.0	83
21.02.967.2	21	21.06.097.0	68	21.06.213.0	87	21.06.345.0	89	21.06.425.0	91	60.15.011.0	70
21.02.968.2	76	21.06.098.0	66	21.06.214.0	86	21.06.346.0	89	21.06.426.0	92	60.15.013.0	70
21.02.969.2	76	21.06.098.1	66	21.06.215.0	86	21.06.347.0	89	21.06.427.0	92	60.15.022.0	92
21.02.970.2	76	21.06.098.2	66	21.06.216.0	86						
21.02.974.2	76	21.06.098.3	66	21.06.217.0	86						
21.02.976.2	76	21.06.098.4	66	21.06.219.0	87						
21.02.977.2	76	21.06.098.5	66	21.06.220.0	87						
21.02.978.2	76	21.06.100.0	86	21.06.221.0	87						
21.02.979.2	76	21.06.101.0	86	21.06.223.0	87						
21.02.980.2	76	21.06.102.0	86	21.06.225.0	86						
21.02.981.2	74	21.06.103.0	86	21.06.227.0	87						
21.02.982.2	74	21.06.104.0	86	21.06.228.0	87						
21.02.983.2	74	21.06.105.0	86	21.06.229.0	87						
21.02.989.0	78	21.06.106.0	86	21.06.230.0	87						
21.02.990.0	78	21.06.107.0	86	21.06.231.0	87						
21.02.998.0	64	21.06.108.0	86	21.06.232.0	87						
21.02.999.0	78	21.06.109.0	86	21.06.235.0	88						
21.02.999.1	78	21.06.110.0	86	21.06.236.0	88						
21.05.003.2	55	21.06.111.0	87	21.06.237.0	88						
21.05.006.2	56	21.06.112.0	87	21.06.238.0	88						
21.05.007.2	55	21.06.113.0	87	21.06.239.0	88						
21.05.022.2	55	21.06.114.0	86	21.06.240.0	86						
21.05.023.2	56	21.06.115.0	86	21.06.241.0	86						
21.05.025.2	61	21.06.116.0	86	21.06.242.0	86						
21.05.026.2	61	21.06.117.0	86	21.06.243.0	88						
21.05.027.2	60	21.06.118.0	86	21.06.245.0	87						
21.05.028.2	60	21.06.119.0	87	21.06.246.0	87						
21.05.041.2	73	21.06.120.0	87	21.06.247.0	88						
21.05.060.0	97	21.06.121.0	87	21.06.250.0	92						
21.05.061.0	97	21.06.123.0	87	21.06.251.0	86						
21.06.000.0	66	21.06.125.0	86	21.06.255.0	88						
21.06.002.0	67	21.06.127.0	87	21.06.256.0	88						
21.06.003.0	67	21.06.128.0	87	21.06.257.0	88						
21.06.004.0	67	21.06.129.0	87	21.06.258.0	88						
21.06.005.0	66	21.06.130.0	87	21.06.269.0	86						
21.06.007.0	67	21.06.131.0	87	21.06.270.0	86						
21.06.007.0	68	21.06.132.0	87	21.06.271.0	86						



KAM iN ZUBE HÖR

Rund um den Kamin - aktuelle Trends und Neuheiten

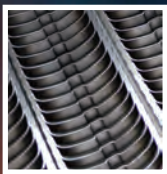

Als österreichisches Unternehmen legt unser Haus höchsten Fokus auf Zuverlässigkeit, Mehrwert und Qualität. Möglich machen dies unsere Repräsentanten, die Beschaffung sowie eine eigene Produktionsstätte in Österreich.

Mit unseren regelmäßigen Produkt-Updates bleiben Sie immer am Puls der Zeit. Erfahren Sie hier aktuelle Neuigkeiten über Trends und Innovationen in Punkto Kaminzubehör, aber auch Impressionen unseres Unternehmens.

As an Austrian company, we place the highest focuses on reliability, added value and quality. This is made possible by our representatives, procurement and our own production facility in Austria. With our regular product updates, you will always have your finger on the pulse. Here you can find the latest news about trends and innovations in fireplace accessories, but also impressions of our company.



En tant qu'entreprise autrichienne, notre maison met l'accent sur la fiabilité, la valeur ajoutée et la qualité. C'est possible grâce à nos représentants, à notre approvisionnement et à notre propre site de production en Autriche.

Grâce à nos mises à jour régulières des produits, vous restez toujours à la pointe du progrès. Découvrez ici les dernières nouvelles concernant les tendances et les innovations en matière d'accessoires de cheminée, mais aussi des impressions de notre entreprise.

Kaminbesteck 3-teilig
 schwarz beschichtet
 Besteck Edelstahl
 Griffe und Sockel Nussholz

Art.-Nr.	cm	cm
21.02.959.2	20,5 x 15	62



Fireplace tool 3 pcs.
 black coated
 accessories stainless steel
 handles and base walnut

Garniture de cheminée 3 pcs.
 époxy noir, accessoires inox
 poignées et base en noyer



Kaminbesteck 3-teilig
 Edelstahl matt gebürstet
 Griffe und Sockel Nussholz

Art.-Nr.	cm	cm
21.02.958.2	20,5 x 15	62



Fireplace tool 3 pcs.
 stainless steel
 handles and base walnut

Garniture de cheminée 3 pcs.
 inox, poignées et base
 en noyer



Holzkorb mit Griffen
 und Sockel in Nussholz
 A) Edelstahl matt gebürstet
 B) schwarz beschichtet

Art.-Nr.	cm	cm
A) 21.02.939.2	60 x 38	44
B) 21.02.940.2	60 x 38	44

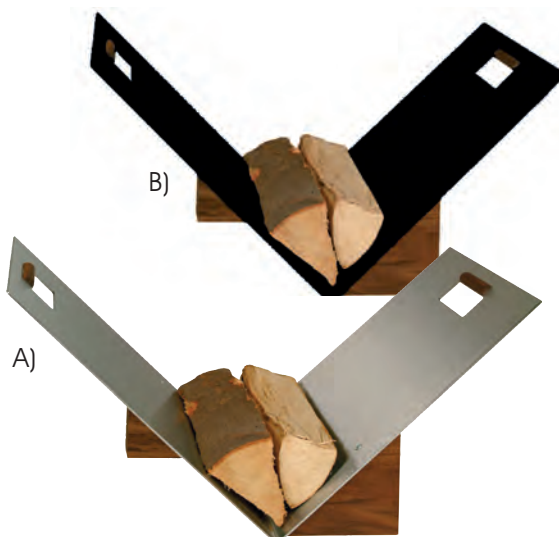

Wood basket with handles
 and base in walnut
 A) stainless steel
 B) black coated

Panier à bûches avec
 poignées et socle en noyer
 A) inox
 B) époxy noir



Kaminbesteck 3-teilig
 schwarz beschichtet
 Besteck Edelstahl
 Griffe Nussholz

Art.-Nr.	cm	cm
21.02.317.2	18 x 14	62



Fireplace tool 3 pcs.
 black coated
 accessories stainless steel
 handles walnut

Garniture de cheminée 3 pcs.
 époxy noir, accessoires inox
 poignées noyer



Kaminbesteck 3-teilig
 anthrazit beschichtet
 Besteck Edelstahl
 Griffe Nussholz

Art.-Nr.	cm	cm
21.02.318.2	18 x 14	62



Fireplace tool 3 pcs.
 anthracite coated
 accessories stainless steel
 handles walnut

Garniture de cheminée 3 pcs.
 époxy anthracite
 accessoires inox
 poignées noyer

Kaminbesteck 3-teilig
 weiß beschichtet
 Besteck Edelstahl
 Griffe Nußholz

Art.-Nr.	cm	cm
21.02.319.2	18 x 14	62



Fireplace tool 3 pcs.
 white coated
 accessories stainless steel
 handles walnut

Garn. de cheminée 3 pcs.
 époxy blanche
 accessoires inox
 poignées noyer



Kaminbesteck 3-teilig
 schwarz beschichtet
 Besteck Edelstahl
 Griffe Nussholz

Art.-Nr.	cm	cm
21.02.956.2	35 x 16	61



Fireplace tool 3 pcs.
 black coated, accessories
 stainless steel, handles walnut

Garniture de cheminée 3 pcs.
 époxy noir, accessoires inox
 poignées et base en noyer



Kaminbesteck 3-teilig
 schwarz beschichtet
 Besteck Edelstahl

Art.-Nr.	cm	cm
21.02.957.2	35 x 16	61



Fireplace tool 3 pcs.
 black coated, accessories
 stainless steel

Garniture de cheminée 3 pcs.
 époxy noir
 accessoires inox

Kaminbesteck 2-teilig
 schwarz Feinstruktur beschichtet
 Besteck Edelstahl

Art.-Nr.	cm	cm
21.02.930.2	35 x 24,5	79



Fireplace tool 2 pcs.
 fine structure black coated
 accessories stainless steel

Garniture de cheminée 2 pcs.
 époxy noir structure fine
 accessoires inox





Kaminbesteck 3-teilig
anthrazit beschichtet
Griffe Edelstahl

Art.-Nr.	cm	cm
21.02.348.2	24 x 20	64



Fireplace tool 3 pcs.
anthracite coated
handles stainless steel

Garniture de cheminée 3 pcs.
époxy anthracite
poignées inox



Kaminbesteck 3-teilig
schwarz beschichtet
Griffe Edelstahl

Art.-Nr.	cm	cm
21.02.441.2	24 x 20	64



Fireplace tool 3 pcs.
black coated
handles stainless steel

Garniture de cheminée 3 pcs.
époxy noir
poignées inox



Kaminbesteck 3-teilig
Edelstahl matt gebürstet
Griffe Edelstahl

Art.-Nr.	cm	cm
21.02.623.2	24 x 20	64



Fireplace tool 3 pcs.
stainless steel

Garniture de cheminée 3 pcs.
inox

Kaminbesteck 3-teilig
anthrazit beschichtet
Besteck Edelstahl
Griffe Nussholz

Art.-Nr.	cm	cm
21.02.948.2	24 x 20	64



Fireplace tool 3 pcs.
anthracite coated, accessories stainless
steel, handles walnut

Garniture de cheminée 3 pcs.
époxy anthracite, accessoires inox
poignées noyer



Fireplace tool 3 pcs.
stainless steel
handles walnut

Garniture de cheminée 3 pcs.
inox, poignées noyer

Kaminbesteck 3-teilig
Edelstahl matt gebürstet
Griffe Nussholz

Art.-Nr.	cm	cm
21.02.923.2	24 x 20	64



Kaminbesteck 3-teilig
anthrazit beschichtet
A) Griffe Buche
B) Griffe Nussholz

Art.-Nr.	cm	cm
A) 21.02.347.2	24 x 20	64
B) 21.02.947.2	24 x 20	64

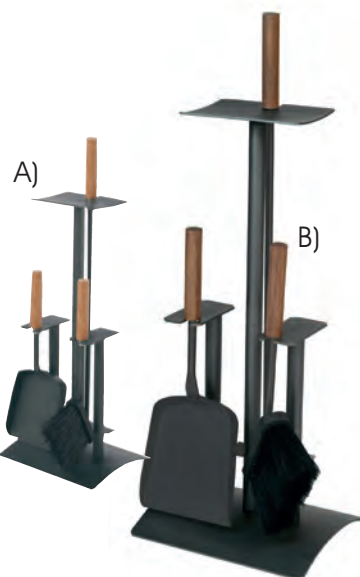

Fireplace tool 3 pcs.
anthracite coated
A) handles beech
B) handles walnut

Garniture de cheminée 3 pcs.
époxy anthracite
A) poignées hêtre
B) poignées noyer



B)

Kaminbesteck 3-teilig
 A) anthrazit beschichtet
 B) schwarz beschichtet
 Besteck Edelstahl
 Griffe Nussholz

Art.-Nr.	cm	cm [
A) 21.02.934.2	Ø 20	65
B) 21.02.935.2	Ø 20	65



Fireplace tool 3 pcs.
 A) anthracite coated
 B) black coated
 accessories stainless steel
 handles walnut

Garniture de cheminée 3 pcs.
 A) époxy anthracite
 B) époxy noir
 accessoires inox
 poignées noyer

Kaminbesteck 3-teilig
 anthrazit beschichtet
 Besteck & Griffe Edelstahl

Art.-Nr.	cm	cm [
21.02.641.2	Ø 20	65



Fireplace tool 3 pcs.
 anthracite coated
 handles stainless steel

Garniture de cheminée 3 pcs.
 époxy anthracite
 poignées inox



Kaminbesteck 3-teilig
 schwarz beschichtet
 Besteck & Griffe Edelstahl

Art.-Nr.	cm	cm [
21.02.640.2	Ø 20	65



Fireplace tool 3 pcs.
 black coated
 handles stainless steel

Garniture de cheminée 3 pcs.
 époxy noir
 poignées inox

Kaminbesteck 3-teilig
 schwarz beschichtet
 Besteck Edelstahl
 Griffe Nussholz

Art.-Nr.	cm	cm
21.02.954.2	24 x 17	61



Fireplace tool 3 pcs.
 black coated, accessories
 stainless steel, handles walnut

Garniture de cheminée 3 pcs.
 époxy noir
 accessoires inox
 poignées noyer



Kaminbesteck 3-teilig
 anthrazit beschichtet
 Besteck & Griffe Edelstahl

Art.-Nr.	cm	cm
21.02.955.2	24 x 17	61



Fireplace tool 3 pcs.
 anthracite coated, accessories
 stainless steel

Garniture de cheminée 3 pcs.
 époxy anthracite
 accessoires inox

Kaminbesteck 3-teilig
 elfenbeinfärbig beschichtet
 Besteck Edelstahl
 Griffe Nussholz

Art.-Nr.	cm	cm
21.02.936.2	Ø 20	65



Fireplace tool 3 pcs.
 ivory coated
 accessories stainless steel
 handles walnut

Garniture de cheminée 3 pcs.
 en couleur ivoire
 accessoires inox
 poignées noyer





Kaminbesteck 3-teilig
 schwarz beschichtet
 Besteck Edelstahl
 Griffe Nussholz

Art.-Nr.	cm	cm [
21.02.928.2	24 x 19	65



Fireplace tool 3 pcs.
 black coated, accessories
 stainless steel, handles walnut

Garniture de cheminée 3 pcs.
 époxy noir, accessoires inox
 poignées noyer

Kaminbesteck 3-teilig
 anthrazit beschichtet
 Besteck & Griffe Edelstahl

Art.-Nr.	cm	cm [
21.02.327.2	24 x 19	65



Fireplace tool 3 pcs.
 anthracite coated, accessoires
 stainless steel

Garniture de cheminée 3 pcs.
 époxy anthracite
 accessoires inox



Kaminbesteck 3-teilig
 anthrazit beschichtet
 Griffe Buche

Art.-Nr.	cm	cm [
21.02.307.2	24 x 19	65



Fireplace tool 3 pcs.
 anthracite coated
 handles beech

Garniture de cheminée 3 pcs.
 époxy anthracite
 poignées hêtre

Kaminbesteck 3-teilig
 A) schwarz beschichtet
 B) anthrazit beschichtet
 Griffe Edelstahl

Art.-Nr.	cm	cm [
A) 21.02.644.2	26 x 21	62
B) 21.02.643.2	26 x 21	62



Fireplace tool 3 pcs.
 A) black coated
 B) anthracite coated
 handles stainless steel

Garniture de cheminée 3 pcs.
 A) époxy noir
 B) époxy anthracite
 poignées inox



B)



A)



Kaminbesteck 3-teilig
 anthrazit beschichtet
 Griffe Nussholz

Art.-Nr.	cm	cm [
21.02.943.2	26 x 21	62



Fireplace tool 3 pcs.
 anthracite coated
 handles walnut

Garniture de cheminée 3 pcs.
 époxy anthracite
 poignées noyer



Kaminbesteck 3-teilig
 schwarz beschichtet
 Griffe Holz schwarz

Art.-Nr.	cm	cm [
21.02.443.2	26 x 21	62



Fireplace tool 3 pcs.
 black coated, wooden
 handles black

Garniture de cheminée 3 pcs.
 époxy noir
 poignées en bois noir



Kaminbesteck 3-teilig
anthrazit beschichtet
Griffe mit Chromkappen

Art.-Nr.	cm	cm
21.02.209.2	32 x 19	74



Fireplace tool 3 pcs.
anthracite coated
handles with chrome caps

Garniture de cheminée 3 pcs.
époxy anthracite
embouts chromés

Kaminbesteck 4-teilig
anthrazit beschichtet
Griffe mit Chromkappen

Art.-Nr.	cm	cm
21.02.204.2	32 x 19	74



Fireplace tool 4 pcs.
anthracite coated
handles with chrome caps

Garniture de cheminée 4 pcs.
époxy anthracite
embouts chromés



Kaminbesteck 3-teilig
anthrazit beschichtet
Griffe mit Chromkappen

Art.-Nr.	cm	cm
21.02.273.2	26 x 21	67



Fireplace tool 3 pcs.
anthracite coated
handles with chrome caps

Garniture de cheminée 3 pcs.
époxy anthracite
embouts chromés

Kaminbesteck 3-teilig
schwarz beschichtet
Griffe Edelstahl

Art.-Nr.	cm	cm
21.02.444.2	Ø 20	63



Fireplace tool 3 pcs.
black coated
handles stainless steel

Garniture de cheminée 3 pcs.
époxy noir
poignées inox



Kaminbesteck 3-teilig
anthrazit beschichtet
Griffe Holz schwarz

Art.-Nr.	cm	cm
21.02.219.2	Ø 20	64



Fireplace tool 3 pcs.
anthracite coated
wooden handles black

Garniture de cheminée 3 pcs.
époxy anthracite
poignées en bois noir



Kaminbesteck 4-teilig
silber antik beschichtet
Griffe Edelstahl

Art.-Nr.	cm	cm
21.02.322.2	24 x 19	53



Fireplace tool 4 pcs.
antique silver finish
handles stainless steel

Garniture de cheminée 4 pcs.
fini argent antique
poignées inox



Kaminbesteck 4-teilig
anthrazit beschichtet
Griffe Holz schwarz

Art.-Nr.	cm	cm
21.02.228.2	Ø 19	70



Fireplace tool 4 pcs.
anthracite coated
wooden handles black

Garniture de cheminée 4 pcs.
époxy anthracite
poignées en bois noir



Kaminbesteck 4-teilig
anthrazit beschichtet
Griffe Buche

Art.-Nr.	cm	cm
21.02.227.2	Ø 19	70



Fireplace tool 4 pcs.
anthracite coated
handles beech

Garniture de cheminée 4 pcs.
époxy anthracite
poignées hêtre



Kaminbesteck 3-teilig
anthrazit beschichtet
Griffe mit Chromkappen

Art.-Nr.	cm	cm
21.02.333.2	19 x 19	60



Fireplace tool 3 pcs.
anthracite coated
handles with chrome caps

Garniture de cheminée
époxy anthracite
embouts chromés

Kaminbesteck 3-teilig
anthrazit beschichtet
Griffe Buche

Art.-Nr.	cm	cm
21.02.343.2	19 x 19	60



Fireplace tool 3 pcs.
anthracite coated
handles beech

Garniture de cheminée 3 pcs.
époxy anthracite
poignées hêtre



Kaminbesteck 4-teilig
anthrazit beschichtet
Griffe mit Chromkappen

Art.-Nr.	cm	cm [
21.02.226.2	Ø 19	70



Fireplace tool 4 pcs.
anthracite coated
handles with chrome caps

Garniture de cheminée 4 pcs.
époxy anthracite
embouts chromés



Kaminbesteck 4-teilig
schwarz beschichtet
A) Griffe Edelstahl
B) Griffe Holz schwarz

Art.-Nr.	cm	cm [
A) 21.02.126.2	Ø 19	70
B) 21.02.128.2	Ø 19	70



Fireplace tool 4 pcs.
black coated
A) handles stainless steel
B) wooden handles black

Garniture de cheminée 4 pcs.
époxy noir
A) poignées inox
B) poignées bois noir

Kaminbesteck 4-teilig
schwarz beschichtet
Griffe Buche

Art.-Nr.	cm	cm [
21.02.127.2	Ø 19	70



Fireplace tool 4 pcs.
black coated
handles beech

Garniture de cheminée 4 pcs.
époxy noir
poignées hêtre





Kaminbesteck 2-teilig
schwarz beschichtet
Stege & Besteckteile Edelstahl
Griffe Nussholz

Art.-Nr.	cm	cm [
21.02.112.2	23 x 15	40,5



Fireplace tool 2 pcs.
black coated
accessoires stainless steel
handles walnut

Garniture de cheminée 2 pcs.
époxy noir, accessoires
inox, poignées noyer

Kaminbesteck 2-teilig
weiß beschichtet
Stege & Besteckteile Edelstahl
Griffe Nussholz

Art.-Nr.	cm	cm [
21.02.110.2	23 x 15	40,5



Fireplace tool 2 pcs.
white coated
accessoires stainless steel
handles walnut

Garniture de cheminée 2 pcs.
époxy blanche, accessoires
inox, poignées noyer



Kaminbesteck 2-teilig
anthrazit beschichtet
Stege & Besteckteile Edelstahl
Griffe Nussholz

Art.-Nr.	cm	cm [
21.02.111.2	23 x 15	40,5



Fireplace tool 2 pcs.
anthracite coated
accessoires stainless steel
handles walnut

Garniture de cheminée 2 pcs.
époxy anthracite, accessoires
inox, poignées noyer



Kaminbesteck 3-teilig
schwarz beschichtet
Besteckteile Edelstahl
Griffe Nussholz

Art.-Nr.	cm	cm
21.02.932.2	Ø 19	46



Fireplace tool 3 pcs.
black coated
handles walnut

Garniture de cheminée 3 pcs.
époxy noir
poignées noyer



Kaminbesteck 3-teilig
anthrazit beschichtet
Griffe Edelstahl

Art.-Nr.	cm	cm
21.02.933.2	Ø 19	46



Fireplace tool 3 pcs.
anthracite coated
handles stainless steel

Garniture de cheminée 3 pcs.
époxy anthracite
poignées inox

Kaminbesteck 3-teilig
schwarz beschichtet
Besteckteile und Sockel Edelstahl
Griffe Nussholz

Art.-Nr.	cm	cm
21.02.949.2	Ø 20	40



Fireplace tool 3 pcs.
black coated, accessoires
and base stainless steel
handles walnut

Garniture de cheminée
époxy noir, poignées noyer
accessoires et base en inox



Kaminbesteck 2-teilig
A) anthrazit beschichtet, Griffe Buche
B) schwarz beschichtet, Griffe Buche
C) schwarz beschichtet,
Griffe Holz schwarz

Art.-Nr.	cm	cm
A) 21.02.376.2	19 x 19	39
B) 21.02.377.2	19 x 19	39
C) 21.02.379.2	19 x 19	39



Fireplace tool 2 pcs.
A) anthracite coated, handles beech
B) black coated, handles beech
C) black coated, wooden
handles black

Garniture de cheminée 2 pcs.
A) époxy anthracite, poignées hêtre
B) époxy noir, poignées hêtre
C) époxy noir, poignées en bois noir



Kaminbesteck 2-teilig
anthrazit beschichtet
Griffe Buche

Art.-Nr.	cm	cm
21.02.346.2	24 x 20	42



Fireplace tool 2 pcs.
anthracite coated
handles beech

Garniture de cheminée 2 pcs.
époxy anthracite
poignées hêtre

Kaminbesteck 2-teilig
anthrazit beschichtet
Griffe Edelstahl

Art.-Nr.	cm	cm
21.02.342.2	24 x 20	42



Fireplace tool 2 pcs.
anthracite coated
handles stainless steel

Garniture de cheminée
époxy anthracite
poignées inox



Kaminbesteck 2-teilig
schwarz beschichtet
Griffe Edelstahl

Art.-Nr.	cm	cm
21.02.442.2	24 x 20	42



Fireplace tool 2 pcs.
black coated
handles stainless steel

Garniture de cheminée 2 pcs.
époxy noir
poignées inox

Kaminbesteck 2-teilig
mit Stauraum

A) anthrazit beschichtet

Griffe Edelstahl

B) schwarz beschichtet, Besteck

Edelstahl, Griffe Nussholz

Art.-Nr.	cm	cm
A) 21.02.966.2	30 x 26	32
B) 21.02.967.2	30 x 26	32



Fireplace tool 2 pcs.

A) anthracite coated,

handles stainless steel

B) black coated, acc. stain-

less steel, handles walnut



Garniture de cheminée 2 pcs.

A) époxy anthracite, poignées inox

B) époxy noir, accessoires inox,

poignées noyer

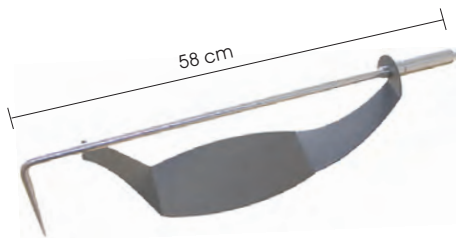

Kaminbesteck 1-tlg.,

Besteck Edelstahl

A) anthrazit beschichtet

B) schwarz beschichtet

C) weiß beschichtet

Art.-Nr.	cm	cm
A) 21.02.447.2	40 x 11	11,5
B) 21.02.448.2	40 x 11	11,5
C) 21.02.449.2	40 x 11	11,5



Fireplace tool 1 pc.

accessoires stainless steel

A) anthracite coated

B) black coated

C) white coated

Garniture de cheminée 1 pc.

accessoires inox

A) epoxy anthracite

B) epoxy noir

C) epoxy blanche



Kaminbesteck 4-tlg.

schwarz beschichtet

Holzgriffe schwarz

Art.-Nr.	cm	cm
21.02.152.2	28 x 13	56



Fireplace tool 4 pcs.

black coated

wooden handles black

Garniture de cheminée 4 pcs.

époxy noir

poignées en bois noir





Kaminbesteck 3-teilig
 Griffe Nussholz
 Wandbefestigung möglich
 A) anthrazit beschichtet
 B) weiß beschichtet

Art.-Nr.	cm	cm [
A) 21.02.374.2	31,5 x 16	62
B) 21.02.375.2	31,5 x 16	62



Fireplace tool 3 pcs.
 handles walnut
 A) anthracite coated
 B) white coated

Garniture de cheminée 3 pcs.
 poignées noyer
 A) époxy anthracite
 B) époxy blanche



Kaminbesteck 3-teilig
 schwarz Feinstruktur beschichtet
 Griffe Edelstahl
 Wandbefestigung möglich

Fireplace tool 3 pcs.
 black coated
 handles stainless steel

Garniture de cheminée 3pcs.
 époxy noir
 poignées inox

Art.-Nr.	cm	cm [
21.02.378.2	31,5 x 16	62



Kaminbesteck 3-teilig
 anthrazit beschichtet
 Griffe Buche
 für Wandbefestigung

Fireplace tool 3 pcs. fixation
 on the wall, anthracite
 coated handles beech

Garniture de cheminée 3 pcs.
 époxy anthracite
 poignées hêtre

Art.-Nr.	cm	cm [
21.02.237.2	28	58



Kaminbesteck 3-teilig
anthrazit beschichtet
Griffe Buche
Wandbefestigung möglich

Art.-Nr.	cm	cm
21.02.231.2	28	63



Fireplace tool 3 pcs.
anthracite coated
handles beech

Garniture de cheminée 3 pcs.
époxy anthracite
poignées hêtre
aussi possible pour montage mural



Kaminbesteck 3-teilig
Edelstahl matt gebürstet
Griffe Buche
Wandbefestigung möglich

Art.-Nr.	cm	cm
21.02.531.2	28	63



Fireplace tool 3 pcs.
stainless steel
handles beech
also possible for mounting
on the wall

Garniture de cheminée 3 pcs.
inox , poignées hêtre

Kaminbesteck 4-teilig
anthrazit beschichtet
Griffe Buche
Wandbefestigung möglich

Art.-Nr.	cm	cm
21.02.230.2	28	63



Fireplace tool 4 pcs.
anthracite coated
handles beech

Garniture de cheminée 4 pcs.
époxy anthracite
poignées hêtre





Holzkorb und Kaminbesteck 3-tlg.
anthrazit beschichtet
Griffe Buche

Art.-Nr.	cm	cm
21.02.220.2	37 x 37	67



Fireplace tool 3 pcs. and basket
anthracite coated
handles beech

Garniture de cheminée 3 pcs.
époxy anthracite
poignées hêtre

Holzkorb
anthrazit beschichtet

Art.-Nr.	cm	cm
21.02.414.2	40 x 36	60



Wood basket
anthracite coated

Panier à bûches
époxy anthracite



Art.-Nr.

21.02.265.2

4 Rollen schwarz passend zu:

4 rolls black to match:

4 rouleaux noirs assortis:

21.02.220.2, 21.02.414.2, 21.02.434.2, 21.02.270.2,
21.02.271.2, 21.02.371.2



Holzkorb
schwarz beschichtet Feinstruktur

Art.-Nr.	cm	cm
21.02.434.2	40 x 36	60



Wood basket
black coated

Panier à bûches
époxy noir

Holzkorb
anthrazit beschichtet

Art.-Nr.	cm	cm
21.02.270.2	37 x 30	51,5



Wood basket
anthracite coated

Panier à bûches
époxy anthracite



Holzkorb
anthrazit beschichtet

Art.-Nr.	cm	cm
21.02.271.2	41 x 35	51,5



Wood basket
anthracite coated

Panier à bûches
époxy anthracite



Holzkorb
schwarz beschichtet

Art.-Nr.	cm	cm
21.02.371.2	37 x 30	51,5



Wood basket
black coated

Panier à bûches
époxy noir

Holzkorb
Edelstahl

Art.-Nr.	cm	cm
21.02.599.2	45 x 30	16



Wood basket, stainless steel

Panier à bûches, inox



Holzkorb
schwarz beschichtet

Art.-Nr.	cm	cm
21.02.399.2	45 x 30	16



Wood basket, black coated

Panier à bûches, époxy noir



Holzkorb
anthrazit beschichtet

Art.-Nr.	cm	cm
21.02.299.2	45 x 30	16



Wood basket, anthracite coated

Panier à bûches, époxy anthracite



Holz- und Pelletskorb
anthrazit beschichtet

Art.-Nr.	cm	cm
21.02.272.2	41 x 30	49



Wood basket, anthracite coated

Panier à bûches, époxy anthracite



Holzkorb mit Rollen
schwarz beschichtet

Art.-Nr.	cm	cm
21.00.264.2	39 x 39	58



Wood basket with wheels
black coated

Panier à bûches avec roues
époxy noir



Holzkorb anthrazit beschichtet
mit Rollen

Art.-Nr.	cm	cm
21.02.208.2	Ø 45	40



Wood basket anthracite coated
with wheels

Panier à bûches avec roues
époxy anthracite

Holzkorb anthrazit beschichtet
mit Rollen

Art.-Nr.	cm	cm
21.02.734.2	60 x 32	42



Wood basket anthracite coated
with wheels

Panier à bûches avec roues
époxy anthracite



Holzwagen
schwarz beschichtet Feinstruktur

Art.-Nr.	cm	cm
21.02.431.2	30,5 x 35	79



Wood basket
black coated

Panier à bûches
époxy noir

Holzwagen
anthrazit beschichtet

Art.-Nr.	cm	cm
21.02.430.2	30,5 x 35	79



Holzwagen
anthrazit beschichtet

Wood basket
anthracite coated

Panier à bûches
époxy anthracite

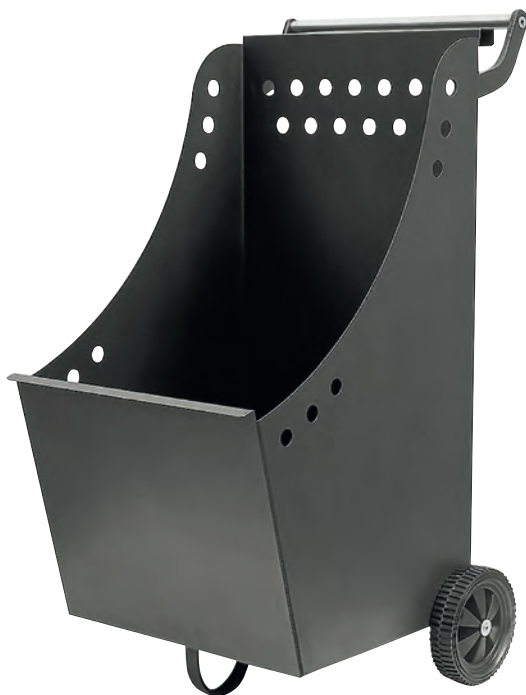

Holzwagen
schwarz beschichtet Feinstruktur

Art.-Nr.	cm	cm
21.02.331.2	40 x 56	85



Wood basket
black coated

Panier à bûches
époxy noir

Holzwagen
anthrazit beschichtet

Art.-Nr.	cm	cm
21.02.330.2	40 x 56	85



Wood basket
anthracite coated

Panier à bûches
époxy anthracite

Brennstoffregal
 Stahlblech 3 mm schwarz
 Feinstruktur beschichtet

Art.-Nr.	cm	cm
21.02.460.2	30 x 30	120



Wood shelf
 steel 3 mm, black coated

Étagère en bois
 tôle d'acier de 3 mm, époxy noir

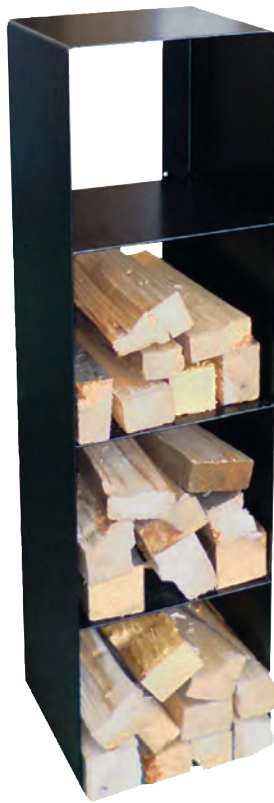

Brennstoffregal
 Metall schwarz beschichtet

Art.-Nr.	cm	cm
21.00.225.2	36 x 31	149



Wood shelf
 metal black coated

Étagère en bois
 métal époxy noir



Brennstoffregal auf Rollen
 schwarz beschichtet

Art.-Nr.	cm	cm
21.00.263.2	39 x 39	126



Wood shelf with wheels, black coated

Étagère en bois, avec roues, époxy noir

Holzkorb schwarz
 zur Wandbefestigung

Art.-Nr.	cm	cm
21.02.153.2	55 x 30	55



wood basket black
 for wall mounting

Panier à bûches noir
 pour montage mural





Kaminbesteck 4-teilig
regeneriertes Leder
Besteck schwarz
A) beige
B) schwarz
C) braun

Art.-Nr.	cm	cm
A) 21.02.752.2	Ø 22	35/60
B) 21.02.767.2	Ø 22	35/60
C) 21.00.278.2	Ø 22	35/60



Fireplace tool 4 pcs.
regenerated leather (beige, black,
brown), accessoires black

Garniture de cheminée 4 pcs.
cuir régénéré (beige, noir, marron)
accessoires noir

Holzkorb, regeneriertes
Leder, mit Rollen
A) beige
B) schwarz
C) braun

Art.-Nr.	cm	cm
A) 21.02.759.2	52 x 38	45
B) 21.02.764.2	52 x 38	45
C) 21.02.762.2	52 x 38	45



Wood basket, regenerated leather,
with roles (beige, black, brown)

Panier à bûches, cuir régénéré,
avec roues (beige, noir, marron)



Kamingarnitur 4-tlg.
anthrazit beschichtet

Art.-Nr.	cm	cm
21.00.273.2		62



Fireplace tool 4 pcs.
anthracite coated

Garniture de cheminée 4 pcs.
époxy anthracite



Regeneriertes Leder wird aus Restfasern der Lederproduktion, mit natürlichen Gerbstoffen, Fettungs- und Bindemittel zu Rollenware verarbeitet. Das regenerierte Leder ist damit ressourcenschonend produziert.



Holzkorb mit Rollen
regeneriertes Leder, schwarz

Art.-Nr.	cm	cm
21.02.766.2	Ø 50	40



Wood basket with wheels
regenerated leather, black

panier à bûches avec roues
encuir noir régénéré

Kaminbesteck, Kunstleder schwarz,
Besteck schwarz, Griffe edelstahlfärbig (Schaufel, Besen, Haken, Zange)

Art.-Nr.	cm	cm
21.02.755.2	30 x 18	63,5



Fireplace tool 4 pcs.
faux leather black
black accessoires, stainless steel colored handles

Garniture de cheminée 4 pcs.
simili cuir, noir, accessoires noir,
poignées couleur inox



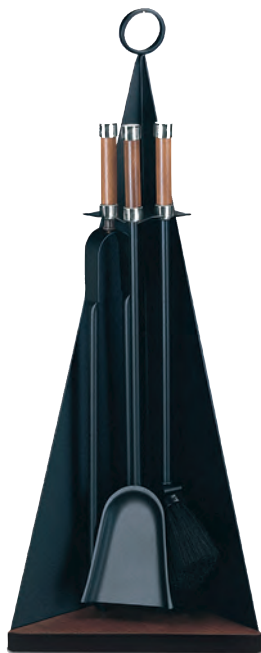

Kaminbesteck 3-teilig
schwarz beschichtet, Griffe und
Sockel Eiche gedämpft

Art.-Nr.	cm	cm
21.02.952.2	31	71



Fireplace tool 3 pcs.
black coated, handles and
base out of steamed oak

Garniture de cheminée 3 pcs.
époxy noir, poignées et base
en chêne étuvé



Kaminbesteck 4-teilig
schwarz beschichtet
(Schaufel, Besen, Haken, Zange)

Art.-Nr.	cm	cm
21.02.769.2	Ø 18	30/61



Fireplace tool 4 pcs.
black coated

Garniture de cheminée 4 pcs.
époxy noir

Kaminbesteck 3-teilig
schwarz beschichtet
Griffe Edelstahl (Schaufel,
Besen, Zange)

Art.-Nr.	cm	cm
21.02.904.2	Ø 18	30/61



Fireplace tool 3 pcs.
black coated
handles stainless steel

Garniture de cheminée 3 pcs.
époxy noir
poignées inox



Kaminbesteck 3-teilig
anthrazit beschichtet
Griffe Edelstahl (Schaufel,
Besen, Schürhaken)

Art.-Nr.	cm	cm
21.02.417.2	Ø 16	30/60



Fireplace tool 3 pcs.
anthracite coated
handles stainless steel

Garniture de cheminée 3 pcs.
époxy anthracite
poignées inox

Kaminbesteck 4-teilig

A) Edelstahl, Griffe und Sockel Eiche gedämpft

B) schwarz beschichtet, Griffe und Sockel Eiche gedämpft

Art.-Nr.	cm	cm
A) 21.02.951.2	15,5 x 15,5	65
B) 21.02.953.2	15,5 x 15,5	65



Fireplace tool 4 pcs.

A) stainless steel, steamed oak handles and base

B) black coated, handles and base steamed oak

Garniture de cheminée 4 pcs.

A) inox, base en chêne étuvé

B) époxy noir, poignées et base en chêne étuvé

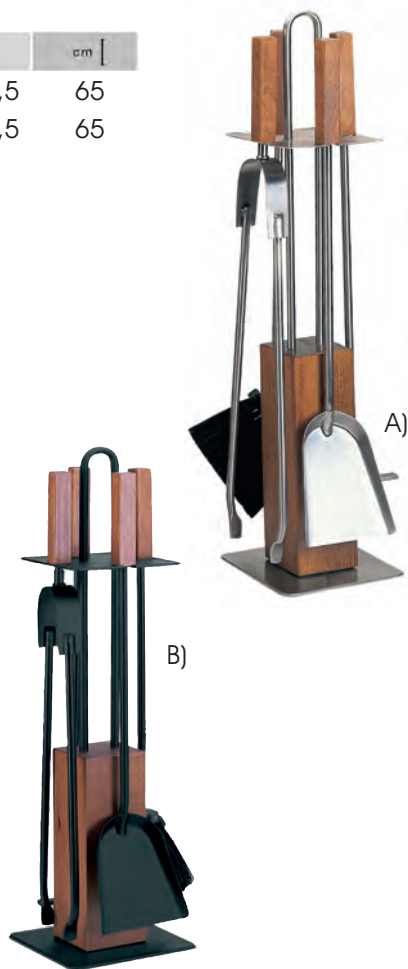

Kaminbesteck 2-teilig

schwarz beschichtet

für Wandmontage geeignet

Art.-Nr.	cm	cm
21.02.825.2	26 x 9	39



Fireplace tool 2 pcs.

black coated

Garniture de cheminée 2 pcs.

époxy noir

Kaminbesteck 3-teilig

schwarz beschichtet

Griffe schwarz

Art.-Nr.	cm	cm
21.00.271.2	Ø 18	42



Fireplace tool 3 pcs.

black coated

handles black

Garniture de cheminée 3 pcs.

époxy noir

poignées noir



Fireplace tool 3 pcs.

black coated

handles black

Garniture de cheminée 3 pcs.

époxy noir

poignées noir



Kaminbesteck 3-teilig

schwarz beschichtet

Griffe schwarz

Art.-Nr.	cm	cm
21.00.272.2	Ø 17	30



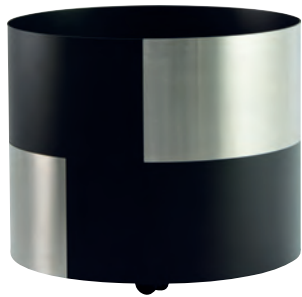

Pelletskorb edelstahlfärbig /
schwarz beschichtet, mit Deckel
und Rollen

Art.-Nr.	cm	cm
21.00.277.2	Ø 39	53,5



Holzkorb edelstahlfärbig /
schwarz beschichtet, mit Rollen

Pellet basket, stainless steel colored,
black coated, with wheels and cover

Art.-Nr.	cm	cm
21.00.276.2	Ø 45	39

Panier à pellets, couleur inox,
epoxy noir, avec roues
et couvercle



Wood basket, stainless steel colored,
black coated, with wheels

panier à bûches, couleur inox,
epoxy noir, avec roues



Kaminbesteck 3-teilig
edelstahlfärbig /
schwarz beschichtet
Griffe edelstahlfärbig

Art.-Nr.	cm	cm
21.00.275.2	Ø 17	60



Fireplace tool 3 pcs.
stainless steel colored /
black coated, handles
stainless steel colored

Garniture de cheminée 3 pcs.
couleur inox / époxy noir,
poignées couleur inox



Kaminbesteck 3-teilig
schwarz beschichtet
Griffe edelstahlfärbig

Art.-Nr.	cm	cm
21.00.274.2	Ø 18	42



Fireplace tool 3 pcs.
black coated, handles
stainless steel colored

Garniture de cheminée 3 pcs.
époxy noir, poignées couleur
inox

ACHTUNG:
MINDESTABSTAND ZUR
OFFENEN FLAMME 30 CM

ATTENTION:
MINIMUM DISTANCE TO THE
OPEN FLAME 30 CM

ATTENTION:
DISTANCE MINIMALE À LA
FLAMME 30 CM

Kaminbesteck 4teilig,
Griffe und Ständer aus Edelstahl,
Sockel aus gehärtetem Glas

Art.-Nr.	cm	cm
21.00.207.2	Ø 66,5	27



Stainless steel handles and stand,
tempered glass base

Poignées et support en inox,
base en verre trempé

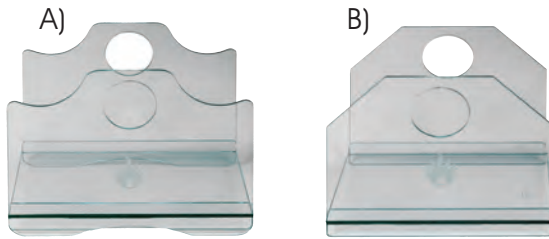

Holzkorb aus gehärtetem Glas

Art.-Nr.	cm	cm
21.02.485.2	43 x 33	32
21.02.484.2	35 x 31	30



Wood basket
tempered glass

Panier à bûches
en verre trempé



Kaminbesteck 4teilig,
aus gehärtetem Glas

A) Besteck und Füße verchromt
B) Besteck und Füße aus Messing

Art.-Nr.	cm	cm
A) 21.02.026.2	25 x 14	68
B) 21.02.025.2	25 x 14	68



Fireplace set 4 pcs.
made of tempered glass
A) acc. and feet chrome-plated
B) accessoires and feet brass

Garniture de cheminée 4 pcs.
en verre trempé
A) accessoires et pieds chromées
B) accessoires et pieds en couleur
laiton

Funkenschutz aus gehärtetem Glas

Art.-Nr.	cm	cm
21.02.027.2	76 x 16,3	50



Fire screen
tempered glass

Grille de protection
en verre trempé

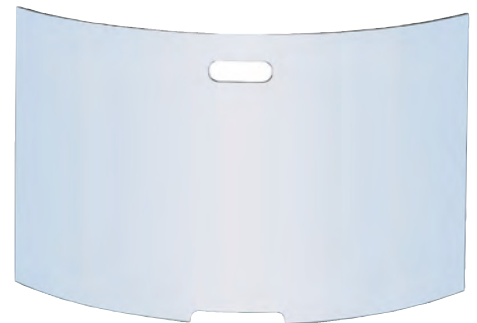

Funkenschutz aus gehärtetem Glas
A) Füße vermessingt
B) Füße verchromt

Fire screen tempered glass
A) Feet brassed
B) Feet chromed

Art.-Nr.	cm	cm
A) 21.02.050.2	65 x 16	50
B) 21.02.052.2	65 x 16	50



Grille de protection
en verre trempé
A) Pieds laitonés
B) Pieds chromés

Kaminbesteck 4-teilig
Edelstahl



Art.-Nr.	cm	cm
21.02.903.2	19 x 16	66



Fireplace tool 4 pcs.
stainless steel

Garniture de cheminée 4 pcs.
inox

Kachelofenbesteck 4-teilig
schwarz beschichtet
Griffe aus Messing



Art.-Nr.	cm	cm
21.02.043.2	Ø 21	85



Fireplace tool 4 pcs.
black coated
brass handles

Garniture de cheminée 4 pcs.
époxy noir
poignées en laiton

Kaminbesteck 4-teilig
schwarz beschichtet
Griffe aus Holz

Art.-Nr.	cm	cm
21.00.270.2	18	71



Fireplace tool 4 pcs.
black coated
wooden handles

Garniture de cheminée 4 pcs.
époxy noir, poignées en bois



Kaminbesteck 4-teilig
aus Messing

Art.-Nr.	cm	cm
21.02.042.2	Ø 17,5	89



Fireplace tool 4 pcs.
brass

Garniture de cheminée 4 pcs.
laiton



Kaminbesteck 4-teilig, schwarz
beschichtet, Griffe Messing

Art.-Nr.	cm	cm
21.02.009.2	Ø 21	68



Fireplace tool 4 pcs.
black coated
brass handles

Garniture de cheminée 4 pcs.
époxy noir, poignées en laiton



Kaminbesteck 4-teilig
aus Messing, Griffe mit Holzeinlage

Art.-Nr.	cm	cm
21.02.010.2	32 x 19	73



Fireplace tool 4 pcs.
brass, handles with wood inlay

Garniture de cheminée 4 pcs.
laiton, poignées avec incrustation de bois



Holzkorb Messing

Art.-Nr.	cm	cm
21.02.030.2	50 x 33	34



Wood basket, brass

Panier en bois, laiton

Kaminbesteck 4-teilig
aus Messing

Art.-Nr.	cm	cm
21.02.014.2	Ø 18	70



Fireplace tool 4 pcs.
brass

Garniture de cheminée 4 pcs.
laiton



Kaminbesteck 4-teilig
vermessingt

Art.-Nr.	cm	cm
21.02.032.2	22	60



Fireplace tool 4 pcs.
brass plated

Garniture de cheminée 4 pcs.
laiton plaqué



Pellets-Box, schwarz beschichtet,
Fassungsvermögen 25 kg

Art.-Nr.	cm	cm
21.00.260.2	Ø 38	50



Pellet box, black coated,
capacity 25 kg

Boîte à pellets, revêtement noir,
capacité 25 kg



Pellets-Box, schwarz beschichtet,
Fassungsvermögen 20 kg

Art.-Nr.	cm	cm
21.00.242.2	32,5 x 31	43,5



Pellet box, black coated,
capacity 20 kg

Boîte à pellets, revêtement noir,
capacité 20 kg



Pellets-Box, schwarz beschichtet,
Fassungsvermögen 30 kg, (ohne
Entnahmebecher)

Art.-Nr.	cm	cm
21.00.261.2	39 x 39	52



Pellet box, black coated,
capacity 30 kg, (without the shovel)

Boîte à pellets, revêtement noir,
capacité 30 kg, (sans pelle)



Pellets-Box, schwarz beschichtet,
Fassungsvermögen 40 kg

Art.-Nr.	cm	cm
21.00.240.2	65 x 35	45



Pellet box, black coated,
capacity 40 kg

Boîte à pellets, revêtement noir,
capacité 40 kg

Pelletsbehälter mit Rollen, schwarz beschichtet, Deckel Holz schwarz, Füllmenge 30 kg

Art.-Nr.	cm	cm
21.02.146.2	50 x 40	54



Pellet box, black coated, cover in black wood, capacity 30 kg, with wheels

Boîte à pellets, revêtement noir, capacité 30 kg, avec roues, couvercle en bois noir



Pelletsbehälter mit Rollen, schwarz beschichtet, mit Füllanzeige, Füllmenge 30 kg

Art.-Nr.	cm	cm
21.02.144.2	40 x 40	65



Pellet box, black coated, capacity 30 kg, with wheels

Boîte à pellets, revêtement noir, capacité 30 kg, avec roues

Pellets-Box mit Rollen, schwarz beschichtet, Füllmenge 30 kg

Art.-Nr.	cm	cm
21.00.244.2	39 x 39	50



Pellet box, black coated, capacity 20 kg

Boîte à pellets, revêtement noir, capacité 20 kg





Pellets-Box, schwarz beschichtet, Füllmenge 45 kg, mit Rollen und integrierter Pellettschaufel

Art.-Nr.	cm	cm
21.00.259.2	Ø 40	70



Pellet box, black coated, capacity 45 kg, with wheels and integrated shovel

Boîte à pellets, revêtement noir, capacité 45 kg, avec roues et pelle intégré



Brennkorb für Pellets, schwarz beschichtet. VE: 6 Stk.

Art.-Nr.	cm	cm
21.02.465.2	24 x 24	18

Pellet burning basket, black coated



Panier de combustion pour pellets, revêtement noir

(DE) Zum Abbrand von Holzpellets in Öfen, welche normalerweise mit Scheitholz befeuert werden.
 (EN) For burning wooden pellets in stoves which are normally fuelled by firewood.
 (FR) Pour la combustion de pellets de bois dans des poêles normalement alimentés par des bûches.
 (NL) Voor het verbranden van houtpellets in kachels die normaal worden gestookt met houtblokken.



Pellets-Box, schwarz beschichtet, Füllmenge 35 kg, mit Rollen

Art.-Nr.	cm	cm
21.00.258.2	Ø 38	52



Pellet box, black coated, capacity 35 kg, with wheels

Boîte à pellets, revêtement noir, capacité 35 kg, avec roues

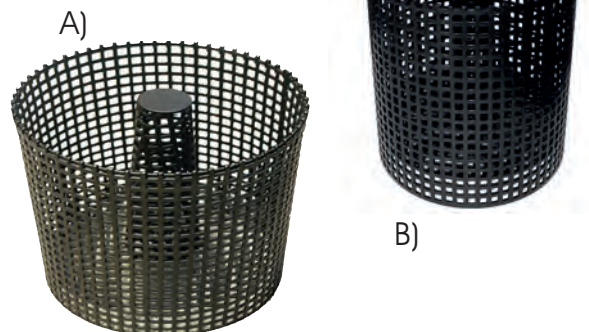

Brennkorb für Pellets, schwarz beschichtet

Art.-Nr.	cm	cm	VE
A) 21.02.466.2	Ø 24	17,5	6
B) 21.02.455.2	Ø 17	17,5	12

Pellet burning basket, black coated



Panier de combustion pour pellets, revêtement noir



Schaufel
schwarz beschichtet

Art.-Nr.	cm	cm
21.02.419.2	35	17



Shovel black coated

Pelle époxy noir



Pelletschaufel
schwarz beschichtet

Art.-Nr.	cm	cm
21.00.257.2	Ø 12	23



Pellet shovel, black coated

Pelle à granulés, époxy noir



Schaufel aus
Aluminium

Art.-Nr.	cm	cm
21.02.421.2	34,5	13



Aluminum shovel

Pelle en aluminium

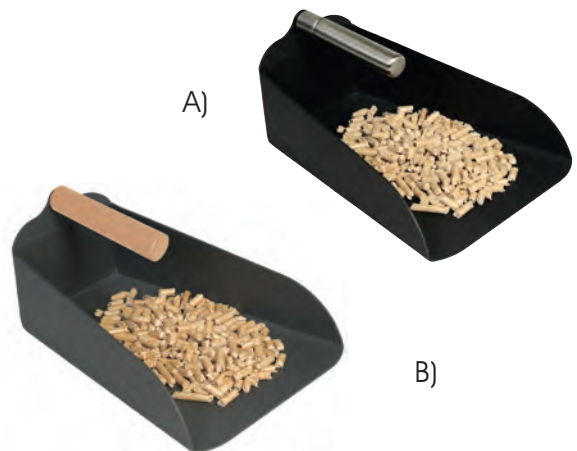

Schaufel
A) schwarz beschichtet,
Griffe Edelstahl
B) anthrazit beschichtet, Griffe Buche

Art.-Nr.	cm	cm
A) 21.02.420.2	23	17
B) 21.02.422.2	23	17



Shovel A) black coated
B) anthracite coated

Pelle A) époxy noir
B) époxy anthracite



Sicherheitsgitter 3 teilig,
schwarz beschichtet

Art.-Nr.	cm	cm
21.02.440.2	84/112/84	74



Safety grille 3 pieces,
black coated

Grille de sécurité en
3 parties, époxy noir

Sicherheitsgitter mit Tür
schwarz beschichtet
3 Mittelteile mit 72 cm
2 Seitenteile mit 32 cm

Art.-Nr.	cm	cm
21.02.450.2	278	71



Safety grille with door,
metal black coated
3 middle parts each 72 cm
2 side parts each 32 cm

Grille de sécurité
avec porte, époxy noir
3 parties centrales de 72 cm
2 parties latérales de 32 cm



Feuerböcke, anthrazit beschichtet,
mit Chromkappen, paarweise

Art.-Nr.	cm	cm
21.02.206.2	38	25



2x Fire dog, anthracite coated,
with chrome caps

2x Tréteau de feu,
époxy anthracite, avec
capuchons chromés





Funkenschutz
schwarz beschichtet

Art.-Nr.	cm	cm
21.02.763.2	28/57/28	80



Fire-screen, coated black

Pare-feu, époxy noir



Funkenschutz, schwarz
beschichtet, Grifflöcher mit Leder

Art.-Nr.	cm	cm
21.00.262.2	17,5/55/17,5	80



Fire-screen, coated black,
handle holes with leather

Pare-feu, époxy noir,
trous de poignée avec cuir



Funkenschutz
schwarz lackiert

Art.-Nr.	cm	cm
21.02.439.2	75	48



Fire-screen, black lacquered

Pare-feu, noir laqué



Funkenschutz
anthrazit beschichtet

Art.-Nr.	cm	cm
21.02.736.2	75	58



Fire-screen, coated anthracite

Pare-feu, époxy anthracite

ACHTUNG: Abstand zur
offenen Flamme: 30 cm

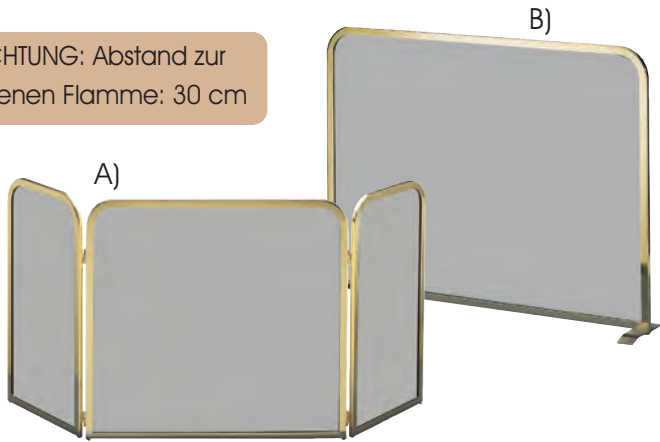

Funkenschutzgitter Rauchglas
getönt, Rahmen aus Messing

Art.-Nr.	cm	cm
A) 21.02.019.2	23,5 / 52 / 23,5	48
B) 21.02.020.2	65	49



Fire screen, smoked glass
brass frame

Pare-feu, verre teinté
cadre en laiton

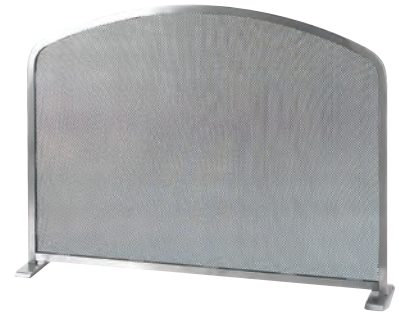

Funkenschutz Edelstahl
matt gebürstet, Gitter anthrazit

Art.-Nr.	cm	cm
21.02.535.2	65	49



Fire-screen, stainless steel,
grille anthracite

Pare-feu, inox brossé mat,
grille anthracite

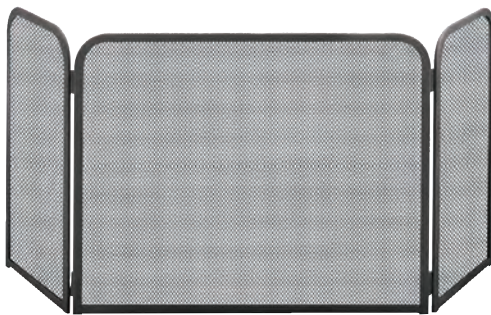

Funkenschutz
anthrazit beschichtet

Art.-Nr.	cm	cm
21.02.205.2	25 / 57 / 25	48



Fire-screen, coated anthracite

Pare-feu, époxy anthracite



Funkenschutz Edelstahl
matt gebürstet, Gitter anthrazit

Art.-Nr.	cm	cm
21.02.735.2	75	58



Fire-screen, stainless steel,
grille anthracite

Pare-feu, inox brossé mat,
grille anthracite

13



Kaminbesteck 4-teilig
anthrazit beschichtet
Griffe Edelstahl

Fireplace tool 4 pcs.
anthracite coated
handles stainless steel

Art.-Nr.	cm	cm
21.02.344.2	23 x 15	66

Garniture de cheminée 4 pcs.
époxy anthracite
poignées inox



Kaminbesteck 4-teilig
schwarz beschichtet
Griffe Edelstahl

Art.-Nr.	cm	cm
21.02.844.2	23 x 15	66



Fireplace tool 4 pcs.
black coated, handles stainless steel

Garniture de cheminée 4 pcs.
époxy noir, poignées inox



Kaminbesteck 4-teilig, mit LED Licht
schwarz beschichtet, Griffe Edel-
stahl, ohne Batterien

Fireplace tool 4 pcs., with LED light,
black coated, handles stainless
steel, without batteries (2x AA)

Art.-Nr.	cm	cm
21.02.344.LED	23 x 15	66

Garniture de cheminée 4 pcs.
avec LED, époxy noir, poignées
inox, sans batteries (2x AA)



Kaminbesteck 3-teilig
schwarz beschichtet
Griffe edelstahlfärbig

Fireplace tool 3 pcs.
black coated, handles stain-
less steel colored

Art.-Nr.	cm	cm
21.02.706.2	22 x 15	66

Garniture de cheminée 3 pcs.
époxy noir, poignées couleur
inox





Kaminbesteck 4-teilig
silber/anthrazit beschichtet
Griffe edelstahlfärbig

Fireplace tool 4 pcs.
silver/anthracite coated
handles stainless steel colored

Art.-Nr.	cm	cm
21.02.744.2	23 x 15	58



Garniture de cheminée 4 pcs.
époxy argent/anthracite
poignées couleur inox

Kaminofen Set 2-teilig
bestehend aus:
Kaminbesteck 21.02.744.2 und
Holzkorb 21.02.035.2

Art.-Nr.	cm	cm
21.02.757.2	23 x 15	58
	41 x 30	50



Fireplace stove set 2-piece
consisting of:
Fireplace set 21.02.744.2 and
wood basket 21.02.035.2



Set de poêle à bois en 2 parties
composé de:
Garn. de cheminée 21.02.744.2
et Panier à bois 21.02.035.2

Kaminbesteck 4-teilig
schwarz beschichtet
Griffe und Einsatz edelstahlfärbig

Fireplace tool 4 pcs.
black coated
handles stainless steel colored

Art.-Nr.	cm	cm
21.02.740.2	28 x 16	68



Garniture de cheminée 4 pcs.
époxy noir
poignées couleur inox



Kaminbesteck 3-teilig
schwarz beschichtet

Fireplace tool 4 pcs.
black coated

Art.-Nr.	cm	cm
21.00.202.2	20 x 14	43



Garniture de cheminée 4 pcs.
époxy noir



Kaminbesteck 4-teilig
anthrazit beschichtet
Griffe Edelstahl

Art.-Nr.	cm	cm
21.02.125.2	Ø 19	70



Fireplace tool 4 pcs.
anthracite coated
handles stainless steel

Garniture de cheminée 4 pcs.
époxy anthracite
poignées inox

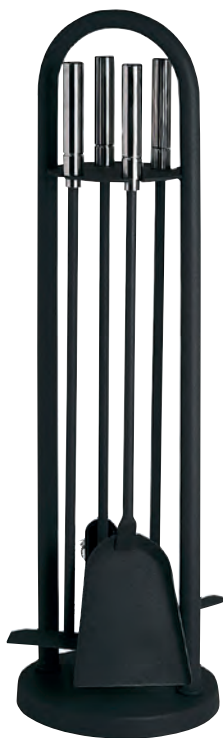

Kaminbesteck 4-teilig
schwarz beschichtet
Griffe Edelstahl

Art.-Nr.	cm	cm
21.02.130.2	Ø 19	70



Fireplace tool 4 pcs.
black coated
handles stainless steel

Garniture de cheminée 4 pcs.
époxy noir, poignées inox

Kaminbesteck 3-teilig, Edelstahl
matt gebürstet, Besteck anthrazit,
Griffe Edelstahl

Art.-Nr.	cm	cm
21.02.701.2	23 x 15	66



Fireplace tool 3 pcs.
stainless steel, acc. anthracite
handles stainless steel

Garniture de cheminée 3 pcs.
inox, accessoires anthracite
poignées inox





Kaminbesteck 4-teilig, Edelstahl matt gebürstet, Besteckteile schwarz beschichtet, Griffe Edelstahl

Art.-Nr.	cm	cm
21.02.725.2	22 x 16	68



Fireplace tool 4 pcs.
stainless steel, acc. black
handles stainless steel

Garniture de cheminée 4 pcs.
inox, accessoires noir
poignées inox



Kaminbesteck 4-teilig
edelstahlfärbig, Griffe Edelstahl

Art.-Nr.	cm	cm
21.02.739.2	23 x 15	68



Fireplace tool 4 pcs.
stainless steel colored
handles stainless steel

Garniture de cheminée 4 pcs.
couleur inox, poignées inox



Kaminbesteck 4-teilig,
Edelstahl matt gebürstet

Art.-Nr.	cm	cm
21.02.539.2	23 x 15	66



Fireplace tool 4 pcs.
stainless steel

Garniture de cheminée 4 pcs.
inox

Kaminbesteck 3-teilig
anthrazit beschichtet
Griffe Holz

Art.-Nr.	cm	cm
21.02.711.2	Ø 23	64



Fireplace tool 3 pcs.
anthracite coated
handles wood

Garniture de cheminée 3 pcs.
époxy anthracite
poignées bois



Kaminbesteck 3-teilig
anthrazit beschichtet
Griffe Edelstahl

Art.-Nr.	cm	cm
21.02.792.22	Ø 23	64



Fireplace tool 3 pcs.
anthracite coated
handles stainless steel

Garniture de cheminée
3 pcs., époxy anthracite,
poignées inox

Kaminbesteck 3-teilig,
schwarz beschichtet
A) Griffe Holz
B) Griffe Edelstahl

Art.-Nr.	cm	cm
A) 21.02.751.22	Ø 23	64
B) 21.02.791.22	Ø 23	64



Fireplace tool 3 pcs.
black coated
A) handles wood
B) handles stainless steel

Garniture de cheminée
3 pcs., époxy black
A) poignées bois
B) poignées inox





Kaminbesteck 4-teilig
anthrazit beschichtet
mit Holzgriffen

Art.-Nr.	cm	cm
21.02.721.2	Ø 20	73



Fireplace tool 4 pcs.
anthracite coated
handles wood

Garniture de cheminée 4 pcs.
époxy anthracite
poignées bois



Kaminbesteck 3-teilig
anthrazit beschichtet
mit Holzgriffen

Art.-Nr.	cm	cm
21.02.728.2	Ø 15	58



Fireplace tool 3 pcs.
anthracite coated
handles wood

Garniture de cheminée 3 pcs.
époxy anthracite
poignées bois



Kaminbesteck 3-teilig
anthrazit beschichtet
mit Holzgriffen

Art.-Nr.	cm	cm
21.02.718.2	Ø 18	64



Fireplace tool 3 pcs.
anthracite coated
handles wood

Garniture de cheminée 3 pcs.
époxy anthracite
poignées bois

Kaminbesteck 3-teilig
anthrazit beschichtet
Griffe Holz

Art.-Nr.	cm	cm
21.02.741.2	23 x 16,5	60



Fireplace tool 3 pcs.
anthracite coated
handles wood

Garniture de cheminée 3 pcs.
époxy anthracite
poignées bois



Kaminbesteck 3-teilig
anthrazit beschichtet
Griffe Holz schwarz

Art.-Nr.	cm	cm
21.02.243.2	26 x 21	62



Fireplace tool 3 pcs.
anthracite coated
handles wood black

Garniture de cheminée
3 pcs., époxy anthracite,
poignées bois noir

Kaminbesteck 4-teilig
anthrazit beschichtet
Griffe und Sockel Holz

Art.-Nr.	cm	cm
A) 21.02.717.2	Ø 19	6



Fireplace tool 4 pcs.
anthracite coated
handles and base wood

Garniture de cheminée
4 pcs., époxy anthracite,
poignées et socle bois





Kaminofen Set 2-teilig
edelstahlfärbig, bestehend aus:
Kaminbesteck 21.02.730.2 und
Holzkorb 21.02.542.2

Art.-Nr.	cm	cm
21.02.731.2	Ø 22	70
	48 x 38	41



Fireplace stove set 2-piece
stainless steel colored, consisting of:
Fireplace set 21.02.730.2 and
wood basket 21.02.542.2

Set de poêle à bois en 2 parties
couleur inox, composé de:
Garn. de cheminée 21.02.730.2
et Panier à bois 21.02.542.2

Kaminbesteck 4-teilig, Edelstahl
matt gebürstet, Besteck anthrazit,
Griffe Edelstahl

Art.-Nr.	cm	cm
21.02.540.2	Ø 18	65



Fireplace tool, 4-pcs, stainless
steel, accessories anthracite,
handles stainless steel

Garniture de cheminée 4 pcs.,
inox, accessoires anthracite,
poignées inox



Kaminbesteck 3-teilig, Sockel und
Besteckstäbe Edelstahl, Standrohr
und Griffe edelstahlfärbig

Art.-Nr.	cm	cm
21.02.730.2	Ø 22	70



Fireplace tool 3 pcs.
base and accessoires stainless
steel, stand and handles stainless
steel colored

Garniture de cheminée 3 pcs.,
socle et accessoires inox, tube et
poignées de couleur inox





Kaminbesteck 3-teilig, Ständer und Griffe Edelstahl, Besteckteile Stahl vernickelt

Fireplace tool 3 pcs. stainless steel, accessoires nickel plated

Art.-Nr.	cm	cm
21.02.723.2	20 x 20	66



Garniture de cheminée 3 pcs., inox, accessoires nickelé



Kaminbesteck 3-teilig, Edelstahl

Art.-Nr.	cm	cm
21.02.729.2	12 x 12	61



Fireplace tool 3 pcs. stainless steel

Garniture de cheminée 3 pcs. inox

Kaminbesteck 3-teilig, edelstahlfärbig

Fireplace tool 3 pcs. color stainless steel

Art.-Nr.	cm	cm
21.02.708.2	22 x 16	70



Garniture de cheminée 3 pcs. couleur inox



Kaminbesteck 4-teilig, Edelstahl, Griffe schwarz

Fireplace tool 4 pcs. stainless steel, handles black

Art.-Nr.	cm	cm
21.02.743.2	Ø 18	62



Garniture de cheminée 4 pcs. inox, poignées noir

Kaminbesteck "Ritter" 3-teilig
aus Gusseisen
schwarz beschichtet

Art.-Nr.	cm	cm
21.02.830.2	22 x 13	73



Fireplace tool "Knight" 3 pcs.
casted iron, black coated

Garniture de cheminée 3 pcs.
chevalier en fer fonte, époxy noir,



Kaminbesteck "Ritter" 3-teilig
aus Gusseisen
A) edelstahlfärbig
B) antikfärbig

Art.-Nr.	cm	cm
21.02.832.2	22 x 13	73
21.02.831.2	22 x 13	73



Fireplace tool "Knight" 3 pcs.
casted iron
A) color stainless steel
B) antique colored

Garniture de cheminée 3 pcs.
chevalier en fer fonte,
A) couleur inox
B) couleur antique

Kaminbesteck "Holzfäller" 3-teilig
aus Gusseisen
A) silbergrau
B) Messing antik

Art.-Nr.	cm	cm
21.02.834.2	21 x 30	73
21.02.836.2	21 x 30	73



Fireplace tool "Woodsmen"
3 pcs. casted iron
A) silvergrey
B) brass antique

Garniture de cheminée
bûcheron fer fonte, 3 pcs.
A) gris argenté
B) laiton antique



Kaminbesteck 4-teilig
Schmiedeeisen schwarz lackiert,
patiniert, mit messingfärbiger Kugel

Art.-Nr.	cm	cm
21.05.003.2	24x24	69



Fireplace tool 4 pcs.
wrought iron, with brass ball

Garniture de cheminée 4 pcs.
fer forgé, boule serviteur
laitonnée



Kaminbesteck 4-teilig
Schmiedeeisen
mit Messingkugeln

Art.-Nr.	cm	cm
21.05.007.2	27x27	74



Fireplace tool 4 pcs.
wrought iron, with brass balls

Garniture de cheminée 4 pcs.
fer forgé, boule serviteur
laitonnée

Kaminbesteck 3-teilig
Schmiedeeisen schwarz
lackiert, silber patiniert

Art.-Nr.	cm	cm
21.05.022.2	23 x 37	65



Fireplace tool 3 pcs.
wrought iron

Garniture de cheminée 3 pcs.
fer forgé





Kaminbesteck 4-teilig
schwere geschmiedete Ausführung,
schwarz lackiert, mit Holzgriffen

Art.-Nr.	cm	cm
21.05.006.2	21x21	82



Fireplace tool of wrought iron 4 pcs.
wooden handles

Garniture de cheminée 4 pcs.
fer forgé, laquée noir, poignées en bois

Holzkorb
schwarz beschichtet

Art.-Nr.	cm	cm
21.02.034.2	37,5 x 44	31,5



Wood basket,
black coated

Panier à bûches
époxy noir



Holzkorb schwarz lackiert
mit umlegbarem Griff

Art.-Nr.	cm	cm
21.05.023.2	38 x 37	40



Wood basket, black coated, handle foldable

Panier à bûches, époxy noir,
repassage pliable





Holzkorb schwarz beschichtet
mit Chrombügel

Art.-Nr.	cm	cm
21.02.035.2	41 x 30	50



Wood basket, black coated, handle chrome

Panier à bûches, époxy noir,
repassage chromé

Holzkorb edelstahlfärbig
mit umlegbarem Griff

Art.-Nr.	cm	cm
21.02.542.2	48 x 38	41



Wood basket
colour stainless steel, handle foldable

Panier à bûches
couleur inox, repassage pliable



Holzkorb Edelstahl, Grifflöcher und
Fußteil mit Kunststoff eingefasst

Art.-Nr.	cm	cm
21.00.209.2	41 x 33	19



Wood basket, stainless steel

Panier à bûches, inox
trou et pied avec matière
plastique



Holzregal verstellbar, schwarz
inkl. 2 Kanthölzer

Art.-Nr.	cm	cm
21.00.228.2	90 x 34	119



Wooden shelf, adjustable,
black, inkl. 2 wooden slats

Étagère à bois, réglable,
noir, avec 2 lattes de bois



Holzwagen schwarz
mit Gummireifen, Gewicht 15 kg

Art.-Nr.	cm	cm
21.00.223.2	48 x 50	106



Wooden trolley with rubber tires, black

Caddie à bois avec pneu en
caoutchouc, noir

Holzkorb mit Kaminbesteck 4-teilig
schwarz

Art.-Nr.	cm	cm
21.00.208.2	40 x 30	73



Fireplace tool 4 pcs., with
integrated wood basket black

Panier à bûches et garniture de
cheminée 4 pcs., noir

Holzkorb mit Kaminbesteck 4-teilig
schwarz beschichtet
Edelstahl Einlage

Art.-Nr.	cm	cm
21.02.738.2	38 x 33	70



Fireplace tool 4 pcs., with
integrated wood basket, black,
inlet stainless steel

Panier à bûches et garniture de
cheminée 4 pcs., noir
avec insert en inox



Holzwagen mit Kaminbesteck 3-teilig
schwarz beschichtet, Griffe Edelstahl

Art.-Nr.	cm	cm
21.02.756.2	35 x 30	81



Fireplace tool 3 pcs., with
integrated wood basket black

Panier à bûches et garniture de
cheminée 3 pcs., noir



A)

Kaminbesteck 4-teilig

A) antikfärbig

B) edelstahlfärbig

Art.-Nr.	cm	cm
A) 21.02.031.2	24 x 24	63
B) 21.02.631.2	24 x 24	63



Fireplace set 4 pcs.

A) antique coloured

B) stainless steel coloured

Garniture de cheminée 4 pcs.

A) couleur antique

B) couleur inox



B)

Kaminbesteck 4-teilig
silber-antik beschichtet

Art.-Nr.	cm	cm
21.05.028.2	22,5 x 19	66



Fireplace set, 4 pcs.
silver antique coated

Garniture de cheminée 4 pcs.
époxy argent-antique

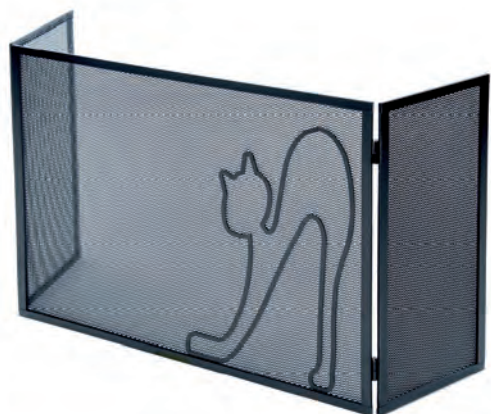

Funkenschutz
silber-antik beschichtet

Art.-Nr.	cm	cm
21.05.027.2	20/60/20	60



Fire screen
antique colored

Pare-feu
couleur antique



Funkenschutz
anthrazit beschichtet

Art.-Nr.	cm	cm
21.02.435.2	24/50/24	50



Fire screen, anthracite coated

Pare-feu, époxy anthracite



Funkenschutz 3-teilig
Rahmen und Gitter schwarz

Art.-Nr.	cm	cm
21.05.025.2	20,5/59,5/20,5	60



Fire screen, black

Pare-feu, noir



Funkenschutz, einteilig
Rahmen und Gitter schwarz

Art.-Nr.	cm	cm
21.05.026.2	80	55



Fire screen, black

Pare-feu, noir



Funkenschutz Rahmen Edelstahl,
Gitter anthrazit

Art.-Nr.	cm	cm
21.02.635.2	25/50/25	50



Fire screen, stainless steel
grille anthracite

Pare-feu, inox, grille anthracite



Besteckteile
anthrazit beschichtet
Griff Buche

Accessoires cheminées
époxy anthracite
avec poignée hêtre



- 21.02.254.2 Scherenzange
Pince à buches, H = 56 cm
- 21.02.255.2 Schaufel
Pelle, H = 58 cm
- 21.02.256.2 Besen
Balai, H = 54 cm
- 21.02.257.2 Schürhaken
Crochet, H = 57 cm
- 21.02.262.2 Schaber
Raclette, H = 57 cm



Besteckteile
Edelstahl,
Griff Buche

Accessoires cheminées
inox, avec
poignée hêtre



- 21.02.554.2 Scherenzange
Pince à buches, H = 57 cm
- 21.02.555.2 Schaufel
Pelle, H = 56 cm
- 21.02.556.2 Besen
Balai, H = 56 cm
- 21.02.557.2 Schürhaken
Crochet, H = 57 cm
- 21.02.263.2 Schaber
Raclette, H = 57 cm



Besteckteile
anthrazit beschichtet
Griff Holz schwarz

Accessoires cheminées
époxy anthracite,
avec poignée en bois noir



- 21.02.246.2 Scherenzange
Pince à buches, H = 56 cm
- 21.02.247.2 Schaufel
Pelle, H = 57 cm
- 21.02.248.2 Besen
Balai, H = 56 cm
- 21.02.249.2 Schürhaken
Crochet, H = 57 cm
- 21.02.259.2 Schaber
Raclette, H = 57 cm



Besteckteile
Edelstahl matt gebürstet
Griff Edelstahl

Accessoires cheminées
inox brossé mat,
avec poignée inox



- 21.02.559.2 Scherenzange
Pince à buches, H = 57,5 cm
- 21.02.560.2 Schaufel
Pelle, H = 57 cm
- 21.02.561.2 Besen
Balai, H = 54 cm
- 21.02.562.2 Schürhaken
Crochet, H = 57,5 cm
- 21.02.264.2 Schaber
Raclette, H = 58 cm



Besteckteile
anthrazit beschichtet
Griffe mit Chromkappen

Accessoires cheminées
époxy anthracite,
avec embouts chromé



- 21.02.250.2 Kohlenzange
Pince à buches, H = 58,5 cm
- 21.02.251.2 Schaufel
Pelle, H = 59,5 cm
- 21.02.252.2 Besen
Balai, H = 56 cm
- 21.02.253.2 Schürhaken
Crochet, H = 57 cm
- 21.02.260.2 Schaber
Raclette, H = 57 cm



Besteckteile
Edelstahl matt gebürstet,
Griff Nussholz

Accessoires cheminées
inox brossé mat,
avec poignée noyer



- 21.02.913.2 Schaufel
Pelle, H = 58 cm
- 21.02.914.2 Besen
Balai, H = 58 cm
- 21.02.915.2 Schürhaken
Crochet, H = 55,5 cm



Besteckteile
anthrazit beschichtet
Griff Nussholz

Accessoires cheminées
époxy anthracite,
avec poignée noyer



- 21.02.910.2 Schaufel
Pelle, H = 58 cm
- 21.02.911.2 Besen
Balai, H = 57,5 cm
- 21.02.912.2 Schürhaken
Crochet, H = 57,5 cm





Besteckteile
silber antik beschichtet,
Griff Edelstahl

21.02.366.2
Besen
H = 30 cm
Balai

21.02.368.2
Schaufel
B/H = 13/36 cm
Pelle

Accessoires cheminées
époxy argent antique,
avec poignée inox



Besteckteile
anthrazit beschichtet,
Griff Edelstahl

21.02.364.2
Besen
H = 30 cm
Balai

21.02.365.2
Schaufel
B/H = 13/36 cm
Pelle

Accessoires cheminées
époxy anthrazite,
avec poignée inox

Besteckteile Edelstahl

Accessoires cheminées
inox

21.02.563.2
Besen
H = 31,5 cm
Balai

21.02.565.2
Schürhaken
H = 46 cm
Crochet

21.02.564.2
Schaufel
H = 36 cm
Pelle

21.02.570.2
Schaber
H = 48,5 cm
Raclette



Besteckteile Edelstahl
Griff Nussholz

21.02.916.2
Besen
H = 34,5 cm
Balai

21.02.918.2
Schaber
H = 57 cm
Raclette

Accessoires cheminées
inox, poignée noyer

21.02.917.2
Schaufel
H = 34,5 cm
Pelle



Besteckteile Edelstahl
matt gebürstet,
Griff Buche

Accessoires cheminées
inox brossé mat,
avec poignée hêtre

21.02.566.2
Besen
H = 29,5 cm
Balai

21.02.567.2
Schürhaken
H = 46 cm
Crochet

21.02.568.2
Schaufel
H = 34 cm
Pelle

21.02.569.2
Schaber
H = 47 cm
Raclette



21.00.375.2
 Kehrschaufel-Set
 Schaufel verzinkt mit Holzgriff,
 Besen mit Holzgriff

pelle et balai



Schaufelfläche:
 B/H = 21,5/23,5 cm
 Gesamtlänge = 44cm
 Besen: L = 30 cm

Kachelofenbestecke
 Länge 70 cm

21.02.571.2
 Schaufel, Edelstahl
 pelle et balai, inox



21.02.572.2
 Schaber, Edelstahl
 raclette, inox



21.02.998.0
 Ersatzbesen mit zwei
 Bohrlöchern, Rosshaar

balais en remplacement

B/T = 11/3,5 cm
 Borstenlänge = 75 mm



21.00.370.2
 Kohleschaufel
 verzinkt mit Holzgriff

pelle acier galvanisé
 avec poignée bois

Schaufelfläche
 B/H = 10/18 cm
 Griff: Länge = 40 cm



Stocheisen, Feuerhaken
 und Aschekratzer,
 8 mm mit Holzgriff,
 Kappe + Ringöse

pique, tisonnier,
 râteau à cendres

21.00.371.2 Stocheisen
 21.00.372.2 Feuerhaken
 21.00.373.2 Aschekratzer



21.02.578.2
 Pizzabesen Aluminium

balai, aluminium
 L = 162 cm

21.02.577.2
 Pizzaschaufel Aluminium

pelle, aluminium
 L/B = 200/32 cm

21.02.579.2
 Pizzadreher Aluminium,
 Platte Edelstahl

crochet, aluminium
 L/B = 168/21 cm



21.02.821.2
 Schaufel/Besen schwarz
 B/L = 17/38 cm
 pelle et balai, noir



21.02.824.2
 Kaminset 2-teilig
 schwarz beschichtet

Set de cheminée
 2 accessoires, époxy noir



Schaufel L/B - 36,5/17 cm
 Besen L - 37 cm

21.02.820.2
 Schaufel/Besen schwarz
 B/L = 17/36,5 cm
 pelle et balai, noir





Asche-Eimer verzinkt mit Griff und Deckel oval, Inhalt ca. 15l
(Ersatzdeckel = 21.02.457.2)
(couvercle de remplacement)

Art.-Nr.	cm	cm
21.02.452.2	34 x 24	30



Ash bucket, galvanised, oval with cover

Seaux à cendres déco, ovale, avec couvercle



Asche-Eimer verzinkt, mit Griff und Deckel, oval, Inhalt ca. 24l
(Ersatzdeckel = 21.02.458.2)
(couvercle de remplacement)

Art.-Nr.	cm	cm
21.02.453.2	40 x 28	35



Ash bucket, galvanised, oval with cover

Seaux à cendres déco, ovale, avec couvercle



Asche-Eimer anthrazit, mit Griff und Deckel, oval, Inhalt ca. 15l
(Ersatzdeckel = 21.02.467.2)
(couvercle de remplacement)

Art.-Nr.	cm	cm
21.02.462.2	34 x 24	30



Ash bucket, anthracite, oval with cover

Seaux à cendres déco, anthracite ovale, avec couvercle



Asche-Eimer anthrazit, mit Griff und Deckel, oval, Inhalt ca. 24l
(Ersatzdeckel = 21.02.468.2)
(couvercle de remplacement)

Art.-Nr.	cm	cm
21.02.463.2	40 x 28	35



Ash bucket, anthracite, oval with cover

Seaux à cendres déco, anthracite ovale, avec couvercle

Aschesauger ohne Motor
Volumen 17 l, mit Metallfilter

Art.-Nr.	cm	cm
21.06.005.0	Ø 27,6	28,6
VE 4 Stk., 1 Palette = 48 Stk.		



Ash cleaner
without motor

Vide cendre
sans moteur



Aschesauger ohne Motor
Volumen 18 l, mit Metallfilter

Art.-Nr.	cm	cm
21.06.000.0	Ø 28	29
VE 4 Stk., 1 Palette = 48 Stk.		



Ash cleaner
without motor

Vide cendre
sans moteur



Aschesauger mit Motor
Akku betrieben, edelstahlfärbig
Volumen 17 l, Ø/H = 27,6/28,6 cm

Art.-Nr.	cm	cm
21.06.098.0	27,6	28,6
VE 4 Stk., 1 Palette = 40 Stk.		



Volumen: 12 l, Stromspannung: 18 V
Stromstärke: 110 Watt, Akku: 2000 mAh
Laufzeit: 20 min, Luftdurchsatz: 16 l/sec.
Feuerabweisender Hepafilter mit Metall-
gehäuse, Metallschlauch sowie Alu-Düse
mit Saug- und Blaufunktion

Volume: 12 l, power voltage: 18 V
power: 110 watt, battery: 2000 mAh, Running time: 20 min, Air
flow: 16 l/sec. Filter: fire-repellent hepa filter with
metal housing, Accessories: metal hose, aluminum
nozzle Additional benefits: Blow function, large
handle for easy carrying

Capacité: 12 L, Voltage, 18 V, Puissance: 110 Watt,
Accu rechargeable: 2000 mAh, temps d'aspiration:
20 min., Force d'aspiration: 16 L/ sec., Filtre: résistant
au feu Hepa avec récipient cendres en metal
Accessories: tuyau flexible en métal embout en alu-
minium, fonction de soufflage, grande poignée pour
un transport facile

Ersatzteile / Spare parts / Pièces détachées

- 21.06.098.1 Hepafilter / Filtre Hepa
- 21.06.098.2 Düse / Nozzle / Buse
- 21.06.098.3 Schlauch / Tube / Tuyau
- 21.06.098.4 Ladeeinheit / Chargingtray /
Étui de recharge
- 21.06.098.5 Ersatzakku / Battery / Batterie

Aschesauger mit Motor
Volumen 18 l, 1200 W

Art.-Nr.	cm	cm
21.06.095.0	Ø 27,6	28,6

VE 4 Stk.
1 Europalette = 36 Stk.
1 Jumbopalette = 72 Stk.



21.06.015.0 Ersatzfilter / Filtre

Hepafilter mit Metallgittergeflecht,
Aluschlauch 1 m, Saug- und
Blasfunktion, Lautstärke: 80 dB (A),
Max. Luftstrom: 25l/sec., 150 cm
Kabel, CE, GS geprüft

Vide cendre avec moteur,
1.200 W, 18 L, tube 1 m, Filtre HEPA avec
protection, Mesure bruit 80 dB (A),
Flux d'air : 25l/sec.,
fil électrique 150 cm,
CE, testes aux normes GS



Aschesauger mit Motor
Volumen 18 l, 1200 W

Art.-Nr.	cm	cm
21.06.091.0	Ø 29	33
21.06.091.5*	Ø 29	33

*) Schweizer Stecker
avec fiche pour prise, utilisé en suisse

VE 4 Stk.
1 Europalette = 36 Stk.
1 Europalette überstehend = 48 Stk.



220-240 V, mit zusätzlichem
Metallfilter, abwaschbar,
Schlauchlänge 1,5 m,
Geprüft mit neuem GS, CE,
ROHS, REACH, PAK

Vide cendre avec moteur,
avec filtre lavable et filtre
métallique, longueur
du flexible 1,5 m

Ersatzteile / Spare parts / Pièces détachées für 21.06.091.0

- 21.06.091.1 Ersatzfilter / Filtre de remplacement
- 21.06.091.2 Metallfilter / Filtre métallique
- 21.06.091.3 Fiberglasfilter / Filtre en fibre de verre
- 21.06.093.3 Ersatzschlauch / Tuyau de rechange
- 21.06.093.5 Düse / Buse
- 21.06.091.99 Deckel mit Motor / Couvercle avec moteur

Aschesauger 21.06.095.0 und 21.06.091.0 mit Saugfunktion und zusätzlicher Blasfunktion (Schlauch oben anstecken)
Aspirateur avec fonction aspirante et soufflante. Visser le tuyau sur le dessus.



Aschesauger mit Motor
Volumen 18 l, 1200 W

Art.-Nr.	cm	cm
21.06.090.0	Ø 30,5	43,5

VE 4 Stk.
1 Europalette = 36 Stk.
1 Jumbopalette = 48 Stk.

mit zusätzlichem großen
Sackfilter und Abklopfbmechanik,
Volumen 18 l, 220-240 V, 1.200 W,
Aluschlauch 1,5 m

Vide cendre avec moteur
avec système ant bourrage
pour la saie

Ersatzteile für die Modelle / Accessoires de rechange pour les aspirateurs
21.06.090.0, 21.06.094.0, 21.06.096.0, 21.06.097.0

- 21.06.002.0 Ersatzschlauch / tuyau en remplacement, L = 100 cm
- 21.06.003.0 Verlängerungsschlauch + Verbindungstück / rallonge / tuyau avec raccord, L = 115 cm
- 21.06.004.0 Düse „schmal“/ buse
- 21.06.007.0 Filter groß / filtre grand en remplacement
- 21.06.008.0 Vlies / rembourrage
- 21.06.019.0 Deckel mit Motor / couvercle avec moteur



Aschesauger mit Motor
Volumen 18 l, 1200 W

Art.-Nr.	cm	cm
21.06.094.0	Ø 30,5	43,5

VE 4 Stk.
1 Europalette = 36 Stk.
1 Jumbopalette = 48 Stk.



150 cm Aluschlauch, 250 cm Kabel,
mit Abklopfbmechanik und
zusätzlichem Metallfilter über dem
Sackfilter (mehr Schutz für den Motor).
Geprüft mit neuem GS, CE, ROHS,
REACH, PAK

Vide cendre avec moteur
testes aux normes GS, CE, ROHS, REACH, PAK
avec système anti bourrage pour la suie

Aschesauger mit Motor und Rollen
Volumen 18 l, 1.200 W

Art.-Nr.	cm	cm
21.06.096.0	Ø 33	50

VE 4 Stk.
1 Europalette = 30 Stk.
1 Jumbopalette = 48 Stk.

21.06.096.CH wie 21.06.096.0 nur mit
Schweizer Steckernorm

150 cm Aluschlauch, 250 cm Kabel, mit
Abklopfbmechanik und zusätzlichem Metallfilter
über dem Sackfilter (mehr Schutz für den Motor).
Geprüft mit neuem GS, CE, ROHS, REACH, PAK

Vide cendre avec moteur
testes aux normes GS, CE, ROHS, REACH, PAK
avec système anti bourrage pour la suie



Ersatzteile für die Modelle /
Accessoires de rechange pour
les aspirateurs 21.06.094.0,
21.06.096.0, 21.06.097.0

21.06.094.2 Metallfilter / filtre métallique
21.06.007.0 Filter / filtre



Aschesauger mit Motor und
Edelstahlbehälter
Volumen 18 l, 1.200 W

Art.-Nr.	cm	cm
21.06.097.0	Ø 30,5	43,5

VE 4 Stk.
1 Europalette = 36 Stk.
1 Jumbopalette = 48 Stk.



220 V, 150 cm Aluschlauch, 250 cm Kabel,
mit Abklopfbmechanik und zusätzlichem
Metallfilter über dem Sackfilter
(mehr Schutz für den Motor).
Geprüft mit neuem GS, CE, ROHS, REACH, PAK

vide cendre avec moteur
testes aux normes GS, ROHS, REACH, PAK
avec système anti bourrage pour la suie
avec recipient en acier inoxydable



Kaminventilator mit Schwenkfunktion „Oszilo“



Art.-Nr.	cm	cm
21.00.383.2	18/11,9	21,9

Wärmebetriebener Ofenventilator benötigt keine Stromquelle

- Schnellstartfunktion
- Überhitzungsschutz
- 50°Schwenkrotor mit 4 Blatt
- Beweglicher Rotor (separat an- und abschaltbar)
- noch bessere Verteilung der Ofenwärme im Raum
- Starttemperatur am Wärmetauscher: ca. 50°
- optimale Lauftemperatur: 80°C bis max. 350°C
- ab ca. 90°C startet der Schwenkmechanismus
- Luftstrom 150 CFM

Ventilateur de cheminée

- Sans electricite fonctionne a la chaleur du poele,
- Rotation possible,
- Pour surfaces jusqu à 350°
- Temperature min. de depart 50°
- Fonction rapide
- Aide a diffuser la chaleur d ou une economie d'energie
- Tres silencieux et economie

stove fan with swivel function

- Heat exchanger starting temperature: approx. 50°C
- Optimum operating temperature: 80 - 350°C
- Airflow: approx. 150 cbf / min.



Überkarton 4 Stk.
24 Stück im Display

Gewicht: 790 g



Ofenventilator mit Magnetbefestigung

Art.-Nr.	cm	cm
21.00.382.2	17/18	13

Wärmebetriebener Ofen-Ventilator für Rauchrohr mit Magnetbefestigung und Schelle

- Gewicht: 810 g
- Starttemperatur am Wärmetauscher: 50°C
- Optimale Lauftemperatur: 80° bis 350°C
- Luftstrom: 110 CFM
- Überkarton 4 Stk.



Ventilateur de four fonctionnant à la chaleur pour tube de fumée à fixation à aimant et serre-câble

- Poids: 810 g
- Température de démarrage de l'échangeur thermique: 50°C
- Température optimale de fonctionnement: 85° à 350°C
- Flux d'air: 110 CFM

stove fan to put on stovepipe with magnetic application and hose clamp (included)

- Heat exchanger starting temp.:approx. 50°C
- Optimum operating temperature: 85 - 350°C
- Airflow: approx. 110 cbf / min.
- Product weight: 810 grams

Ofenventilator

Art.-Nr.	cm	cm
21.00.381.2	20,5 x 12	19,3

Überkarton 6 Stk.



wärmebetriebener Ventilator (ohne Strom)
 Einsatzbereich von ca. 50° bis 345°C, sorgt für eine
 bessere Wärmeverteilung im Raum und spart dadurch
 Energie, sehr leise und ökonomisch.
 Luftstrom: 140 CFM (ca. 13 m³ pro min.)



Stove fan, distributes the heat in the room (without power
 supply) start working by 50° up to 345 C°, ensures a better
 heat distribution saving power fuel, very quiet,
 air flow: 140 CFM

Ventilateur pour cheminée sans
 courant électrique diffuse la chaleur de la
 cheminée et/ou du poêle,
 Température optimale de fonctionnement:
 50° à 345°C,
 Flux d'air: 140 CFM

Verkaufspalette:
 36 Stück im Display
 B/H/T - 60/108/40 cm



Feuchtigkeits-Messgerät
 Dry PS 7400 inkl. Batterien

Art.-Nr.	cm	cm
60.15.011.0		



Moisture meter

Indicateur
 d'humidité



Feuchtigkeits-Messgerät
 mit großem, digitalem Display,
 Messbereich 5%-40%, Stromversor-
 gung: eine 9 V Batterie

Art.-Nr.	cm	cm
60.15.013.0		



Moisture meter

Testeur d'humidité
 avec écran digital et
 batterie dans sa sacoche
 individuelle, grace à ces
 deux electrodes vous
 mesurez le taux d'humidité



Kohle- und Pelletskorb,
schwarz beschichtet

Art.-Nr.	cm	cm
21.02.353.2	Ø 24-26	24-32



Coal basket, black

Seau a charbon, pellet, cendres



Kohle- und Pelletskorb,
schwarz beschichtet,
Griffe nickelmatt

Art.-Nr.	cm	cm
21.02.350.2	Ø 20-25	45-58



Coal basket, black, handles nickel satin

Seau à charbon, pellet, avec anse
nickel satiné



Allzweckbehälter "Word"
inkl. Deckel, aus Stahlblech,
auch für Holz oder Pellets
geeignet, Füllmenge: 20 kg

Art.-Nr.	cm	cm
21.02.147.2	Ø 39	42



Container "Word" incl. cover, made of
sheet steel, also for wood or pellets
suitable, filling capacity: 20 kg

Panier pour bois ou pellets,
contenance: 20 kg



Allzweckbehälter "Britain"
inkl. Deckel, aus Stahlblech,
auch für Holz oder Pellets
geeignet, Füllmenge: 20 kg

Art.-Nr.	cm	cm
21.02.148.2	Ø 39	42



Container "Britain" incl. cover, made of
sheet steel, also for wood or pellets
suitable, filling capacity: 20 kg

Panier pour bois ou pellets,
contenance: 20 kg



Bodenblech, 0,6 mm, Antik,
schwarzsilber beschichtet,
gehämmert, 4-seitig gesickt

Art.-Nr.	cm	cm
21.00.485.2	50 x 60	0,06
21.00.486.2	60 x 80	0,06



Metal floor plate, black/silver,
hammered

Plaque de métal, noir/argent
martelé

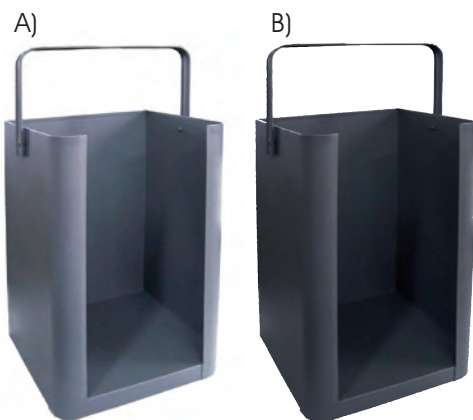

Brikett- Träger für ca. 10 kg Briketts
A) grau beschichtet
B) schwarz beschichtet

Art.-Nr.	cm	cm
A) 21.00.365.2	20 x 20	32,5/42,5
B) 21.00.366.2	20 x 20	32,5/42,5



Briquette carrier for approx. 10 kg
A) grey, B) black

Seau à briquettes conçu pour
env 10 kg A) gris, B) noir



Bodenblech, 0,6 mm, altmessing-
farben schwarz-gold
gehämmert, 4-seitig gesickt

Art.-Nr.	cm	cm
21.00.480.2	50 x 60	0,06
21.00.481.2	60 x 80	0,06



Metal floor plate, black/gold,
hammered

Plaque de métal, noir/or
martelé



Briketzange mit Gelenk

Art.-Nr.	cm	cm
21.00.374.2	23,5	



Briquette tongs

Pince à briquette avec joint

Feuerbock COBRA
für Kamine, Feuerschalen und Öfen

Mit diesem in der Breite stufenlos verstellbaren Feuerbock aus Edelstahl reduzieren Sie den Ausstoß von Ruß, Feinstaub und Stickoxiden und Sie erzielen ein schöneres Flammenbild!

Art.-Nr.	cm	cm
0745178398688	28 x 20	19
0745178398695	33 x 28	19



Patentiertes Produkt aus der Schweiz

Infinitely adjustable fire-dog
made of stainless steel

Tréteau de feu réglable
en acier inoxydable

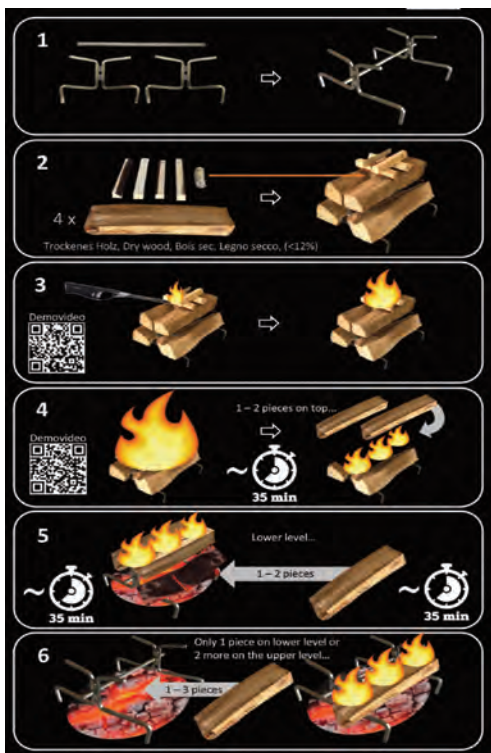

Feuerbock Schmiedeeisen

Art.-Nr.	cm	cm
21.05.041.2	41 x 39	14



Firedog
Wrought iron

Tréteau de feu
en fer forgé

Bodenschutzplatten aus Glas mit einer Stärke von 8 mm
Sondermaße und Sonderformen auf Anfrage!



Floor protection plates made of glass with a thickness of 8 mm
 with grinded edge, chamfering 20 mm
 Special dimensions and special shapes on request!

Plaques de protection de sol en verre d'une épaisseur de 8 mm
 verre clair, avec bords polis, chanfrein 20 mm
 Dimensions spéciales et formes spéciales sur demande!



Glasbodenplatte
 glasklar, mit
 geschliffenen Kanten
 Stärke 8 mm
 Fase 20 mm

21.02.883.2

L/B = 1050/1200 mm



Glasbodenplatte
 glasklar, mit
 geschliffenen Kanten
 Stärke 8 mm
 Fase 20 mm

21.02.878.2

Ø 1000 mm



Glasbodenplatte
 glasklar, mit
 geschliffenen Kanten
 Stärke 8 mm
 Fase 20 mm

21.02.898.2
 21.02.893.2
 21.02.894.2
 21.02.895.2

L/B = 750/900 mm
 L/B = 800/800 mm
 L/B = 1000/1000 mm
 L/B = 1000/1200 mm

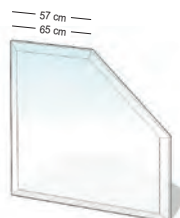

Glasbodenplatte
 glasklar, mit
 geschliffenen Kanten
 Stärke 8 mm
 Fase 20 mm

21.02.982.2
 21.02.983.2

L/B = 1100/1100 mm
 L/B = 1250/1250 mm

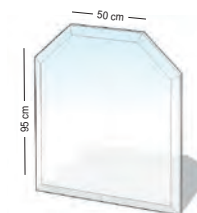

Glasbodenplatte
 glasklar, mit
 geschliffenen Kanten
 Stärke 8 mm
 Fase 20 mm

21.02.889.2

L/B = 1200/1000 mm



Glasbodenplatte
 glasklar, mit
 geschliffenen Kanten
 Stärke 8 mm
 Fase 20 mm

21.02.897.2
 21.02.885.2
 21.02.881.2
 21.02.880.2
 21.02.886.2

L/B = 800/800 mm
 L/B = 1100/1000 mm
 L/B = 1000/1000 mm
 L/B = 1200/1000 mm
 L/B = 1300/1200 mm



Glasbodenplatte
 glasklar, mit
 geschliffenen Kanten
 Stärke 8 mm
 Fase 20 mm

21.02.981.2
 21.02.887.2
 21.02.882.2

L/B = 1100/850 mm
 L/B = 1100/1000 mm
 L/B = 1200/1000 mm

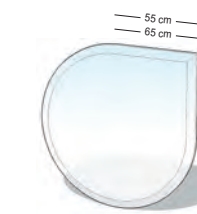

Glasbodenplatte
 glasklar, mit
 geschliffenen Kanten
 Stärke 8 mm
 Fase 20 mm

21.02.884.2
 21.02.888.2

L/B = 1100/1100 mm
 L/B = 1250/1250 mm

Bodenschutzplatten aus Glas mit einer Stärke von 6 mm
Sondermaße und Sonderformen auf Anfrage!



Floor protection plates made of glass with a thickness of 6 mm
 Special dimensions and special shapes on request!

Plaques de protection de sol en verre d'une épaisseur de 6 mm
 Dimensions spéciales et formes spéciales sur demande!

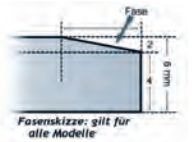

Glasbodenplatte
 glasklar, mit
 geschliffenen Kanten
 Stärke 6 mm
 Fase 20 mm

21.02.861.2
 21.02.860.2

L/B = 1000/1000 mm
 L/B = 1200/1000 mm



Glasbodenplatte
 glasklar, mit
 geschliffenen Kanten
 Stärke 6 mm
 Fase 20 mm

21.02.862.2

L/B = 1200/1000 mm



Glasbodenplatte
 glasklar, mit
 geschliffenen Kanten
 Stärke 6 mm
 Fase 20 mm

21.02.863.2

L/B = 1200/1050 mm

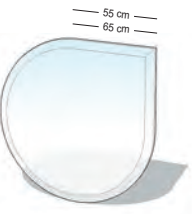

Glasbodenplatte
 glasklar, mit
 geschliffenen Kanten
 Stärke 6 mm
 Fase 20 mm

21.02.864.2
 21.02.868.2

L/B = 1100/1100 mm
 L/B = 1250/1250 mm



Glasbodenplatte
 glasklar, mit
 geschliffenen Kanten
 Stärke 6 mm
 Fase 20 mm

21.02.877.2

Ø = 1000 mm

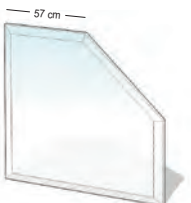

Glasbodenplatte
 glasklar, mit
 geschliffenen Kanten
 Stärke 6 mm
 Fase 20 mm

21.02.962.2

L/B = 1100/1100 mm



Glasbodenplatte
 glasklar, mit
 geschliffenen Kanten
 Stärke 6 mm
 Fase 20 mm

21.02.865.2
 21.02.866.2
 21.02.873.2
 21.02.875.2

L/B = 500/600 mm
 L/B = 600/800 mm
 L/B = 800/800 mm
 L/B = 900/750 mm

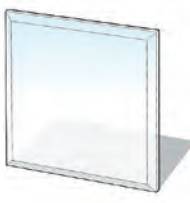

Glasbodenplatte
 glasklar, mit
 geschliffenen Kanten
 Stärke 6 mm
 Fase 20 mm

21.02.874.2
 21.02.876.2

L/B = 1000/1000 mm
 L/B = 1000/1100 mm

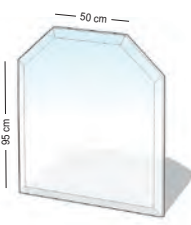

Glasbodenplatte
 glasklar, mit
 geschliffenen Kanten
 Stärke 6 mm
 Fase 20 mm

21.02.869.2

L/B = 1200/1000 mm

Bodenplatten ohne Fase. Floor plates made of glass without bevel.
 Plaques de protection en verre sans chanfrein.



Glasbodenplatte
 glasklar, mit
 geschliffenen Kanten
 Stärke 6 mm

21.02.860.OF

L/B = 1200/1000 mm



Glasbodenplatte
 glasklar, mit
 geschliffenen Kanten
 Stärke 6 mm

21.02.876.OF

L/B = 1000/1100 mm

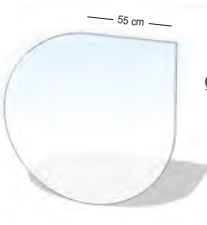

Glasbodenplatte
 glasklar, mit
 geschliffenen Kanten
 Stärke 6 mm

21.02.864.OF

L/B = 1100/1100 mm

Bodenschutzplatten aus Metall pulverbeschichtet mit einer Stärke von 1,5 mm
Sondermaße und Sonderformen auf Anfrage!



Alle Metallplatten in sämtlichen RAL Farben gegen Aufpreis erhältlich!

Floor protection plates made of steel with a thickness of 1,5 mm, powdercoated
 Special dimensions and special shapes on request!

Plaques de protection de sol en verre d'une épaisseur de 1,5 mm, epoxy
 Dimensions spéciales et formes spéciales sur demande!



Metall-
bodenplatte
a) anthrazit
b) struktur-silber
c) schwarz

- a) 21.02.180.2
- b) 21.02.380.2
- c) 21.02.280.2
- a) 21.02.186.2
- b) 21.02.386.2
- c) 21.02.286.2

L/B = 1200/1000 mm
 L/B = 1200/1000 mm
 L/B = 1200/1000 mm
 L/B = 1300/1200 mm
 L/B = 1300/1200 mm
 L/B = 1300/1200 mm



ANTHRAZIT



**STRUKTUR-
SILBER**

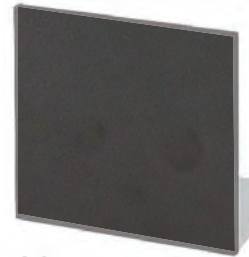

SCHWARZ

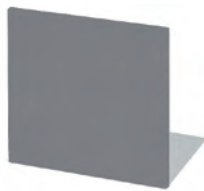

Metall-
bodenplatte
a) anthrazit
b) struktur-silber
c) schwarz

- a) 21.02.185.2
- b) 21.02.385.2
- c) 21.02.285.2
- a) 21.02.193.2
- b) 21.02.393.2
- c) 21.02.293.2

L/B = 750/900 mm
 L/B = 750/900 mm
 L/B = 750/900 mm
 L/B = 800/800 mm
 L/B = 800/800 mm
 L/B = 800/800 mm



Metall-
bodenplatte
a) anthrazit
b) struktur-silber
c) schwarz

- a) 21.02.194.2
- b) 21.02.394.2
- c) 21.02.294.2
- a) 21.02.974.2
- b) 21.02.970.2
- c) 21.02.976.2

L/B = 1000/1000 mm
 L/B = 1000/1000 mm
 L/B = 1000/1000 mm
 L/B = 1200/1200 mm
 L/B = 1200/1200 mm
 L/B = 1200/1200 mm



Metall-
bodenplatte
a) anthrazit
b) struktur-silber
c) schwarz

- a) 21.02.979.2
- b) 21.02.968.2
- c) 21.02.978.2
- a) 21.02.977.2
- b) 21.02.969.2
- c) 21.02.980.2

L/B = 1100/1100 mm
 L/B = 1100/1100 mm
 L/B = 1100/1100 mm
 L/B = 1000/1200 mm
 L/B = 1000/1200 mm
 L/B = 1000/1200 mm



Metall-
bodenplatte
a) anthrazit
b) struktur-silber
c) schwarz

- a) 21.02.181.2
- b) 21.02.381.2
- c) 21.02.281.2
- a) 21.02.182.2
- b) 21.02.382.2
- c) 21.02.282.2

L/B = 1100/850 mm
 L/B = 1100/850 mm
 L/B = 1100/850 mm
 L/B = 1200/1000 mm
 L/B = 1200/1000 mm
 L/B = 1200/1000 mm

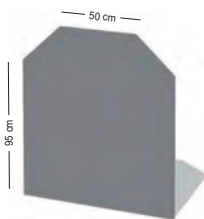

Metall-
bodenplatte
a) anthrazit
b) struktur-silber
c) schwarz

- a) 21.02.189.2
- b) 21.02.389.2
- c) 21.02.289.2

L/B = 1200/1000 mm
 L/B = 1200/1000 mm
 L/B = 1200/1000 mm

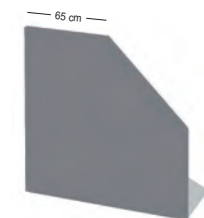

Metall-
bodenplatte
a) anthrazit
b) struktur-silber
c) schwarz

- a) 21.02.187.2
- b) 21.02.387.2
- c) 21.02.287.2

L/B = 1250/1250 mm
 L/B = 1250/1250 mm
 L/B = 1250/1250 mm

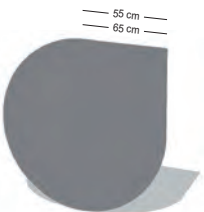

Metall-
bodenplatte
a) anthrazit
b) struktur-silber
c) schwarz

- a) 21.02.184.2
- b) 21.02.384.2
- c) 21.02.284.2
- a) 21.02.188.2
- b) 21.02.388.2
- c) 21.02.288.2

L/B = 1100/1100 mm
 L/B = 1100/1100 mm
 L/B = 1100/1100 mm
 L/B = 1250/1250 mm
 L/B = 1250/1250 mm
 L/B = 1250/1250 mm



Metall-
bodenplatte
a) anthrazit
b) struktur-silber
c) schwarz

- a) 21.02.183.2
- b) 21.02.383.2
- c) 21.02.283.2

L/B = 1050/1200 mm
 L/B = 1050/1200 mm
 L/B = 1050/1200 mm



Metall-
bodenplatte
a) anthrazit
b) struktur-silber
c) schwarz

- a) 21.02.198.2
- b) 21.02.398.2
- c) 21.02.298.2

Ø = 1000 mm
 Ø = 1000 mm
 Ø = 1000 mm

Vorlegeplatten aus Metall
mit einer Stärke von 1,5 mm



Metal floor protection plates.
Plaques frontales de protection en métal.



Metall-
vorlageplatte
a) anthrazit
b) struktur-silber
c) schwarz

- a) 21.02.196.2
- b) 21.02.396.2
- a) 21.02.197.2
- b) 21.02.397.2

L/B = 300/400 mm
L/B = 300/400 mm
L/B = 300/800 mm
L/B = 300/800 mm

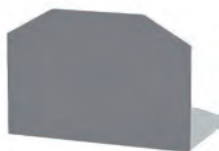

Metall-
vorlageplatte
a) anthrazit
b) struktur-silber
c) schwarz



Metall-
vorlageplatte
a) anthrazit
b) struktur-silber
c) schwarz

- a) 21.02.174.2
- b) 21.02.176.2
- c) 21.02.170.2

L/B = 550/1000 mm
L/B = 550/1000 mm
L/B = 550/1000 mm

- a) 21.02.179.2
- b) 21.02.177.2
- c) 21.02.171.2

L/B = 550/1000 mm
L/B = 550/1000 mm
L/B = 550/1000 mm

- a) 21.02.175.2
- b) 21.02.178.2
- c) 21.02.172.2

L/B = 550/1000 mm
L/B = 550/1000 mm
L/B = 550/1000 mm

Vorlegeplatten aus Glas dienen als Schutz vor Kratzern am Boden.

Floor plates made of glass serve as protection against scratches and fire damage on all floors.

Plaques de protection en verre servent de protection contre les rayures et les dommages causés par le feu sur tous les sols.



Glasvorlegeplatte
mit Fase an drei
Seiten und geschlif-
fenen Kanten
Stärke 6 mm
Fase 20 mm

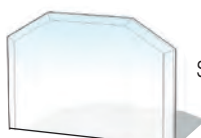

Glasvorlegeplatte
mit Fase an drei
Seiten und geschlif-
fenen Kanten
Stärke 6 mm
Fase 20 mm

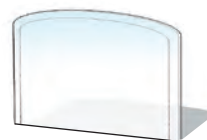

Glasvorlegeplatte
mit Fase an drei
Seiten und geschlif-
fenen Kanten
Stärke 6 mm
Fase 20 mm

21.02.870.2

L/B = 550/1000 mm

21.02.871.2

L/B = 550/1000 mm

21.02.872.2

L/B = 550/1000 mm

Bodenplatten aus Glas mit schwarzem Offset-Druck auf der Unterseite.

Floor plates made of glass with black offset printing.

Plaques de protection en verre avec impression offset noire.



Glasbodenplatte
schwarz
Stärke 8 mm
Fase 20 mm



Glasbodenplatte
schwarz
Stärke 8 mm
Fase 20 mm

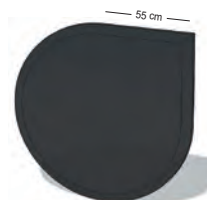

Glasbodenplatte
schwarz
Stärke 8 mm
Fase 20 mm

21.02.851.2

L/B = 1200/1000 mm

21.02.852.2

L/B = 1200/1000 mm

21.02.853.2

L/B = 1100/1100 mm

Auf Wunsch wird bei Abnahme von 28 Platten leihweise ein Verkaufsständer lt. Abb. kostenlos zur Verfügung gestellt

Pour les commandes de 28 plaques nous pouvons prêter un rack pour le stockage



Verkaufsständer für Metall und Glas-Vorlegeplatten

Art.-Nr.	cm	cm
21.02.989.0	80 x 120	97

pour les plaques frontales



Glasbodendichtung
Silikon transparent
einseitig selbstklebend

Art.-Nr.	cm	cm
21.02.960.2	5 lfm.	

Isolation pour plaque de protection en verre



Glasbodendichtung
Silikon transparent
einseitig selbstklebend

Art.-Nr.	cm	cm
21.02.961.2	100 lfm.	

Isolation pour plaque de protection en verre

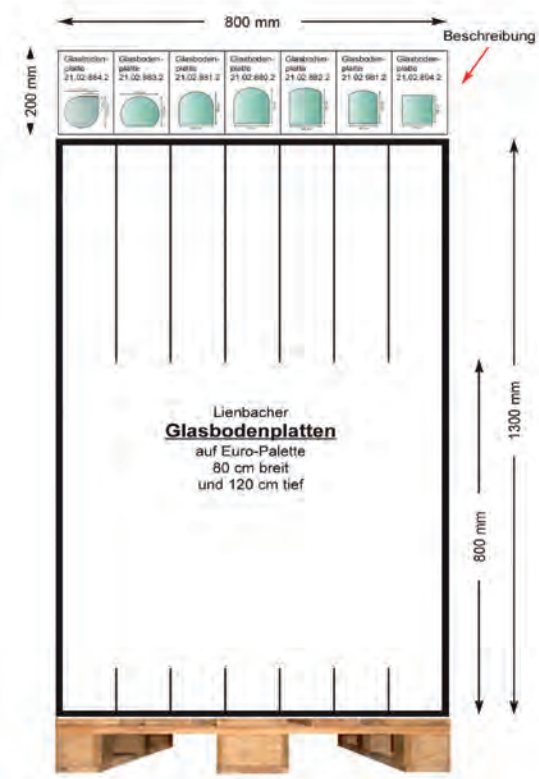

Verkaufsständer für Metall und Glasplatten

Art.-Nr.	cm	cm
21.02.990.0	80 x 120	130

Ausbesserungslack für Metallbodenplatten

Art.-Nr.		
21.02.999.0	anthrazit	10 ml
21.02.999.1	schwarz	10 ml

Laque de réparation



Feuerschale aus Stahlblech
Oberfläche roh

Art.-Nr.	cm	cm
21.00.612.2	60x50	29
21.00.611.2	Ø75	33



Fire bowl without lacquering
surface raw

Cheminée extérieure atre
surface brute



Feuerschale aus Metall
schwarz beschichtet

Art.-Nr.	cm	cm
21.00.610.2	34 x 24	30



Fire-basket

Cheminée extérieur atre



Anzündkamin aus Edelstahl für Grillkohle

Art.-Nr.	cm	cm
21.00.615.0	40 x 28	35



Starter for charcoal

Cheminée allume barbecue
pour charbons de bois



Feuerschale aus Stahlblech, Oberfläche schwarz pulverbeschichtet oder roh, bis zu 600°C hitzebeständig, Schale Materialstärke 3 mm, Füße 5 mm

Art.-Nr.		cm	cm
21.00.608.2	schwarz/black	84,5	51,5
21.00.609.2	roh/raw	84,5	51,5



Fire-bowl
Cheminée extérieure atre

A) Feuerkorb schwarz beschichtet

Art.-Nr.	cm	cm
21.00.602.2	42,5	65

Fire-basket
Cheminée extérieure atre, époxy noir

B) Feuerkorb schwarz beschichtet

Art.-Nr.	cm	cm
21.00.603.2	35	50

Fire-basket
Cheminée extérieure atre, époxy noir



Feuerschale schwarz beschichtet

Art.-Nr.	cm	cm
21.00.600.2	75	40



Fire-bowl
Cheminée extérieure atre, époxy noir



Feuerschale schwarz beschichtet

Art.-Nr.	cm	cm
21.00.604.2	60	40



Fire-bowl
Cheminée extérieure atre, époxy noir

Design-Feuerschale aus Magnesiumoxid, 12,5 kg bis zu 600°C hitzebeständig
inkl. BBQ-Grill und Holzkohlegrill (schwarz beschichtet) und 1 Abdeckung (Gitterdeckel) sowie 1 Haken

Art.-Nr.	cm	cm
21.00.628.2	Ø 60	30

Design fire bowl made of magnesium oxide, 12.5 kg heat resistant up to 600°C incl. BBQ grill and charcoal grill (black coated) and 1 cover (grill lid) and 1 hook

Bol à feu design en magnésium
Résistant à la chaleur jusqu'à 600 ° C
y compris barbecue et grill au charbon de bois (enduit noir) et un couvercle (couvercle en grille) ainsi qu'un crochet



Garten-Kamin schwarz beschichtet,
10 kg bis zu 600°C hitzebeständig,
Materialstärke 0,8 mm
Brennkammer: 24,8 cm - 27,8 cm, H 28,3 cm
Ablagefach: 29,7 cm - 32,5 cm, H 25,5 cm
inkl. 1 Haken

Art.-Nr.	cm	cm
21.00.625.2	Ø 36	125

Garden fireplace

Black coat, heat resistant up to 600 ° C, material thickness 0,8mm, Combustion chamber: 24,8 cm - 27,8 cm, height 28,3 cm, Slot: 29,7 cm - 32,5 cm, height 25,5 cm, included 1 hook

Cheminée de jardin

Noir enduit, résistant à la chaleur jusqu'à 600 ° C, épaisseur du matériau 0,8 mm, Chambre de combustion: 24,8 cm - 27,8 cm, h 28,3 cm
Compartiment de rangement: 29,7 cm - 32,5 cm, hauteur 25,5 cm, y compris un crochet





Baskets and bags out of felt and jute, very strong, for multipurpose use

Jute-Filzkorb
natur, innen grauer Filz, außen Jute

Art.-Nr.	cm	cm
21.02.633.2	55 x 40	35

inside felt, outside jute

intérieur feutre, extérieur jute

Filzkorb oval, anthrazit

Art.-Nr.	cm	cm
21.02.667.2	54 x 36,5	40

Panier en feutre, anthrazit



Filzkorb grau/grey

Art.-Nr.	cm	cm
21.02.632.2	55 x 40	35

Panier en feutre, gris



Filzkorb vielseitig verwendbar
(Holz-, Zeitungs- od. Spielzeugkorb)

Panier en feutre pour bois, journaux

Art.-Nr.,	cm	cm
21.02.673.2 schwarz/black/noir	38 x 35	37
21.02.674.2 beige	38 x 35	37
21.02.676.2 rot/red/rouge	38 x 35	37



Kaminholztrageetasche aus Jute
mit 2 Griffbändern

Art.-Nr.	cm	cm
21.02.669.2	64 x 29	41

Bag out of jute

Sac à bois en toile de jute



Filztasche / Bag out of felt/Ac en feutre

Art.-Nr.	cm	cm
21.02.638.2 grün/green/vert	50 x 34	27
21.02.639.2 grau/grey/gris	50 x 34	27
21.02.658.2 rot/red/rouge	50 x 34	27
21.02.659.2 schwarz/black/noir	50 x 34	27



Kunst-Lederkorb schwarz
mit weißen Nähten, innen mit Vlies

Art.-Nr.,	cm	cm
21.02.634.2	55 x 40	35

Ecoleather black, inside fleece

Panier en simili-cuir, noir,
al' intérieur ovéc toison



Kunst-Lederkorb braun
mit weißen Nähten, innen mit Vlies

Art.-Nr.,	cm	cm
21.02.630.2	55 x 40	35

Ecoleather brown, inside fleece

Panier en simili-cuir, brun, intérieur avéc toison



Kunst-Lederkorb
dunkelbraun, mit Grifföchern

Art.-Nr.	cm	cm
21.02.666.2	45 x 45	45

Ecoleather brown

Panier en simili-cuir brun
pour bois, journaux ..



Universalwanne Flexi
aus widerstandsfähigem Kunststoff
Fassungsvermögen ca. 36 Liter

Art.-Nr.	cm	cm
30.60.025.0	52 x 40	38

Basket out of strong plastic, wood-decor

Panier en plastique solide, décor bois



Wicker-baskets/ Panier en osier



Weidenkorb hellbraun,
mit Jute-Einlage

Art.-Nr.	cm	cm
21.02.617.2	45 x 40	30

with inlet in jute
avec toile de jute



Weidenkorb mit Jute-Einlage

Jute-inlet / toile de jute

Art.-Nr.	cm	cm
21.02.618.2	51 x 51	43



Weidenkorb

Art.-Nr.	cm	cm
21.02.619.2	47	38



Holzschwinge oval / Corbeille à bois

Art.-Nr.	cm	cm
20.00.110.0	40 x 35	16
20.00.110.1	50 x 40	19
20.00.110.2	60 x 45	22



A)

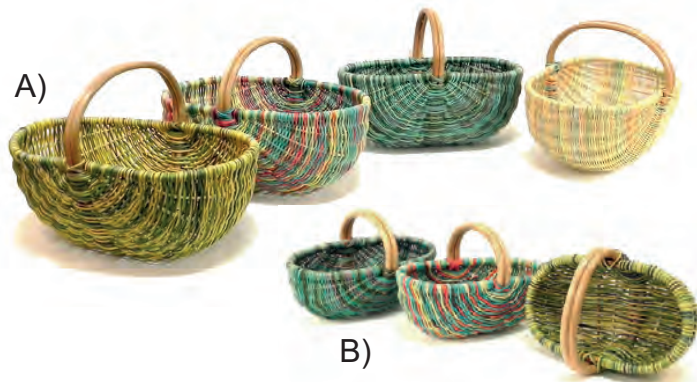

Korb aus Rattan, versch. Farben,
färbig sortiert

Art.-Nr.	cm	cm
A) 20.00.115.0	48 x 31	22/33
B) 20.00.116.0	30 x 20	12/18

Baskets, different colours, sorted
Paniers, différentes couleurs, triées

B)



Einkaufskorb "Vera"

Art.-Nr.	cm	cm
20.00.112.0	40 x 33	21/38

Shopping basket



Einkaufskorb "Holländer"

Art.-Nr.	cm	cm
20.00.113.0	48 x 38	26/42

Shopping basket



Einkaufskorb "Kombi"

Art.-Nr.	cm	cm
20.00.114.0	52 x 35	25/35

Shopping basket

Wicker-baskets / Panier en osier



Weidenkorb

hell: mit Jute-Einlage

dunkel: mit heller Stoffeinlage

bright: with inlet jute

dark: with inlet fabric

couleur vive: avec toile de jute

couleur sombre: avec insert de textile clair

Art.-Nr.		cm	cm
21.02.612.2	hell	50 x 39	46
21.02.612.DK	dunkel	50 x 39	46

Weidenkorb

hell: mit Jute-Einlage

dunkel: mit heller Stoffeinlage

bright: with inlet jute

dark: with inlet fabric

couleur vive: avec toile de jute

couleur sombre: avec insert de textile clair

Art.-Nr.		cm	cm
21.02.609.2		50	50
21.02.609.DK		50	50

Weidenkorb

hell: mit Jute-Einlage

dunkel: mit heller Stoffeinlage

bright: with inlet jute

dark: with inlet fabric

couleur vive: avec toile de jute

couleur sombre: avec insert de textile clair

Art.-Nr.		cm	cm
21.02.603.2		63 x 41	43
21.02.603.DK		63 x 41	43

Weidenkorb

grau, mit heller Stoffeinlage

fabric-inlet/gris, avec insert de textile clair

Art.-Nr.		cm	cm
21.02.628.2		47 x 33	40

Weidenkorb

grau, mit heller Stoffeinlage

fabric-inlet/gris, avec insert de textile clair

Art.-Nr.		cm	cm
21.02.627.2		46 x 33	43

Rauchrohre aus Stahlblech (Stärke 2mm), senothermlackiert mit geschliffenen Schweißnähten
Sheet steel flue pipes (thickness 2 mm), senothermally painted with ground weld seams
Tuyaux & Accessoires (épaisseur 2mm) en laqué senotherm avec point de soudure

Rauchrohr

flue pipe

Tuyau en tôle d'acier

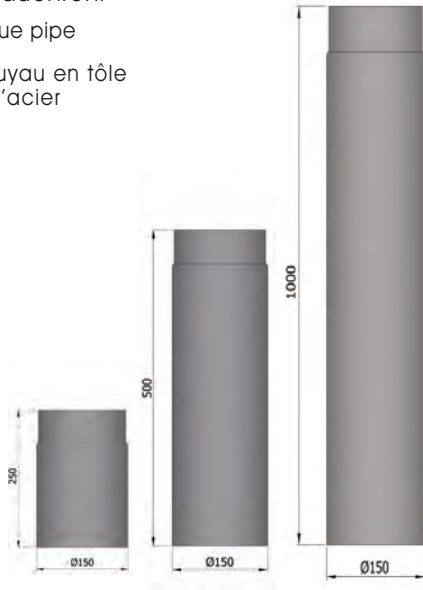

Rauchrohr mit Klappe

Flue pipe with flap

Tuyau avec clapet



schwarz/noir/black

21.06.107.0 150 x 250 mm
 21.06.108.0 150 x 500 mm

grau/gris/grey

21.06.207.0 150 x 250 mm
 21.06.208.0 150 x 500 mm

Rauchrohr mit Klappe/Tür

Flue pipe with flap/door

Tuyau avec clapet

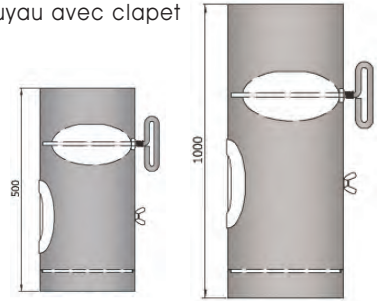

schwarz/noir/black

21.06.109.0 150 x 500 mm
 21.06.110.0 150 x 1000 mm

grau/gris/grey

21.06.209.0 150 x 500 mm
 21.06.210.0 150 x 1000 mm

schwarz/noir/black

21.06.100.0 120 x 250 mm
 21.06.101.0 120 x 500 mm
 21.06.102.0 120 x 1000 mm
 21.06.140.0 150 x 150 mm
 21.06.103.0 150 x 250 mm
 21.06.104.0 150 x 500 mm
 21.06.105.0 150 x 750 mm
 21.06.106.0 150 x 1000 mm

grau/gris/grey

21.06.200.0 120 x 250 mm
 21.06.201.0 120 x 500 mm
 21.06.202.0 120 x 1000 mm
 21.06.240.0 150 x 150 mm
 21.06.203.0 150 x 250 mm
 21.06.204.0 150 x 500 mm
 21.06.205.0 150 x 750 mm
 21.06.206.0 150 x 1000 mm

Rauchrohr mit Kondensring

Flue pipe with condensation ring

Tuyau

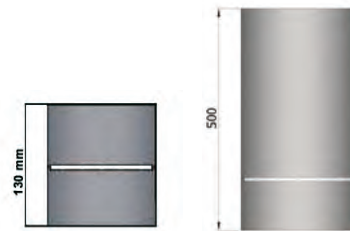

schwarz/noir/black

21.06.141.0 150 x 130 mm
 21.06.142.0 150 x 500 mm

grau/gris/grey

21.06.241.0 150 x 130 mm
 21.06.242.0 150 x 500 mm

Rauchrohr Klappe in Putzdeckel integriert

Flue pipe flap integrated in plaster cover

Tuyau

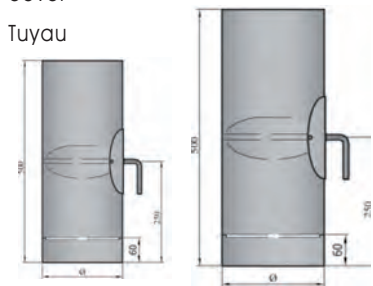

schwarz/noir/black

21.06.169.0 150 x 500 mm
 21.06.170.0 150 x 1000 mm

grau/gris/grey

21.06.269.0 150 x 500 mm
 21.06.270.0 150 x 1000 mm

Rauchrohrbogen

Flue pipe bend

Angle



Rauchrohrbogen bei 90° Variante mit Tür

Flue pipe bend for 90° variant with door

Angle avec regard

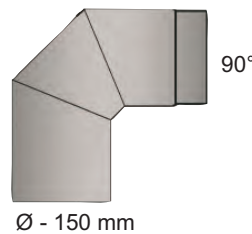

schwarz/noir/black

21.06.116.0 90°/120 mm
 21.06.117.0 90°/150 mm
 21.06.125.0 45°/150 mm

grau/gris/grey

21.06.216.0 90°/120 mm
 21.06.217.0 90°/150 mm
 21.06.225.0 45°/150 mm

Rauchrohrbogen

Sheet steel flue pipe bend

Angle

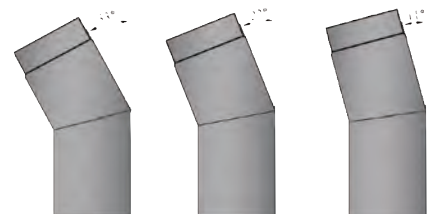

schwarz/noir/black

21.06.171.0 11°/120 mm
 21.06.172.0 22°/120 mm
 21.06.173.0 33°/120 mm

grau/gris/grey

21.06.271.0 11°/120 mm
 21.06.272.0 22°/120 mm
 21.06.273.0 33°/120 mm

Rauchrohrbogen
verstellbar 0-90°, mit Tür

Angle orientable

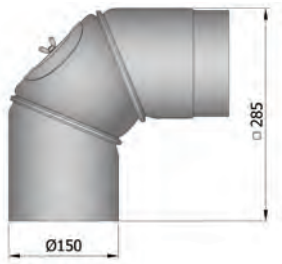

- | | |
|---------------------------|--------|
| schwarz/noir/black | |
| 21.06.119.0 | 150 mm |
| 21.06.123.0 | 120 mm |
| grau/gris/grey | |
| 21.06.219.0 | 150 mm |
| 21.06.223.0 | 120 mm |

Rauchrohrset Standard
geschliffen

Tuyau-Set /affilé

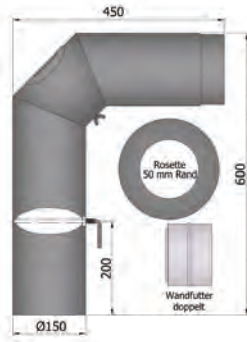

- | | |
|---------------------------|--------|
| schwarz/noir/black | |
| 21.06.121.0 | 150 mm |
| grau/gris/grey | |
| 21.06.221.0 | 150 mm |

Rauchrohrset Fullform
geschliffen

Tuyau-Set /affilé



- | | |
|---------------------------|--------|
| schwarz/noir/black | |
| 21.06.120.0 | 150 mm |
| grau/gris/grey | |
| 21.06.220.0 | 150 mm |

Rauchrohrbogen
Angle

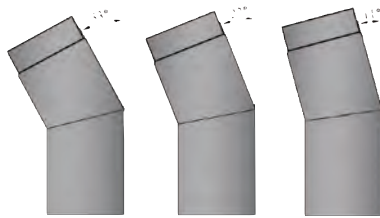

- | | |
|---------------------------|------------|
| schwarz/noir/black | |
| 21.06.111.0 | 11°/150 mm |
| 21.06.112.0 | 22°/150 mm |
| 21.06.113.0 | 33°/150 mm |
| grau/gris/grey | |
| 21.06.211.0 | 11°/150 mm |
| 21.06.212.0 | 22°/150 mm |
| 21.06.213.0 | 33°/150 mm |

Teleskoprohr Ø 150x540 bis 900 mm
senothermlackiert mit geschliffenen
Schweißnähten 2 Rohre + 1 Feststell-
ring, kann man ineinander stecken

Tuyau télescope en acier

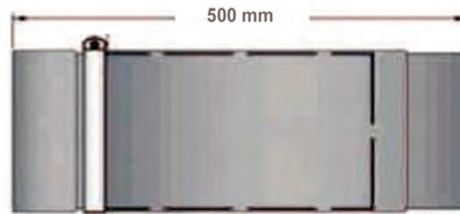

- | | |
|-------------|--------------------|
| 21.06.190.0 | schwarz/noir/black |
| 21.06.290.0 | grau/gris/grey |

Teleskoprohr Ø 150x330 mm
senothermlackiert mit geschliffenen
Schweißnähten, 1 Rohr + 1 breiter
Ring, zum Verlängern eines schon
vorhandenen Rohres

Tuyau télescope en acier

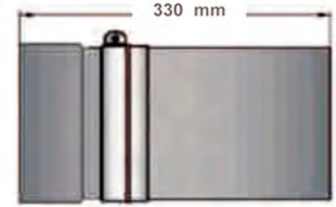

- | | |
|-------------|--------------------|
| 21.06.191.0 | schwarz/noir/black |
| 21.06.291.0 | grau/gris/grey |

S-Bogen
für Rohr 150 mm

Coûde en "S"

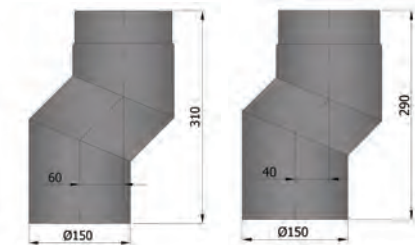

- | | |
|---------------------------|-------|
| schwarz/noir/black | |
| 21.06.145.0 | 60 mm |
| 21.06.146.0 | 40 mm |
| grau/gris/grey | |
| 21.06.245.0 | 60 mm |
| 21.06.246.0 | 40 mm |

Reduzierung
Reduction



- | | |
|---------------------------|------------|
| schwarz/noir/black | |
| 21.06.130.0 | 150/120 mm |
| 21.06.131.0 | 180/150 mm |
| 21.06.132.0 | 150/130 mm |
| grau/gris/grey | |
| 21.06.230.0 | 150/120 mm |
| 21.06.231.0 | 180/150 mm |
| 21.06.232.0 | 150/130 mm |

Erweiterung
Élargissement - rallonge



- | | |
|---------------------------|------------|
| schwarz/noir/black | |
| 21.06.128.0 | 120/150 mm |
| 21.06.129.0 | 150/180 mm |
| 21.06.127.0 | 130/150 mm |
| grau/gris/rei | |
| 21.06.228.0 | 120/150 mm |
| 21.06.229.0 | 150/180 mm |
| 21.06.227.0 | 130/150 mm |

Rosette mit
3 Stiften

Rosace



schwarz/noir/black

21.06.135.0 Rosette 150 mm

grau/gris/grey

21.06.235.0 Rosette 150 mm

Rosette/
Rosace



schwarz/noir/black

21.06.139.0 Rosette 125 mm

21.06.136.0 Rosette 155 mm

grau/gris/grey

21.06.239.0 Rosette 125 mm

21.06.236.0 Rosette 155 mm

Rosette mit Feder

Rosace avec ressort

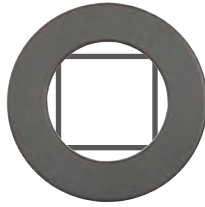

schwarz/noir/black

21.06.137.0 Rosette 150 mm

grau/gris/grey

21.06.237.0 Rosette 150 mm

T-Stück mit Deckel

Pièce 'T' avec couvercle

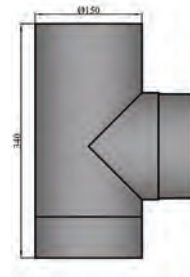

schwarz/noir/black

21.06.143.0 Ø 150 mm

21.06.147.0 Ø 120 mm

grau/gris/grey

21.06.243.0 Ø 150 mm

21.06.247.0 Ø 120 mm

Deckenrosette
mit Doppelwandfutter

Rosace de plafond avec
mandrin double épaisseur

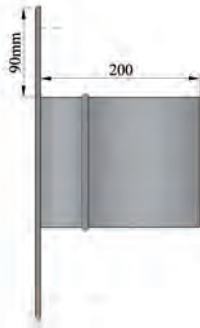

schwarz/noir/black

21.06.156.0 Ø 150 mm

grau/gris/grey

21.06.256.0 Ø 150 mm

Mauermuffe doppelt

Manchon de mur double

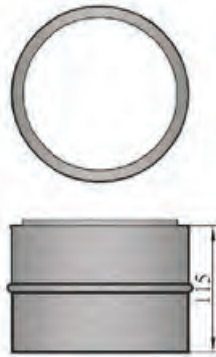

schwarz/noir/black

21.06.138.0 Ø 150 mm

grau/gris/grey

21.06.238.0 Ø 150 mm

Doppelwandfutter mit Mauer-
lasche und Rosette 5 cm

Mandrin avec rabat de mur
et rosace 5 cm



schwarz/noir/black

21.06.155.0 Ø 150 mm

grau/gris/grey

21.06.255.0 Ø 150 mm

Blinddeckel für
Doppelwandfutter

Couvercle borgne avec mandrin

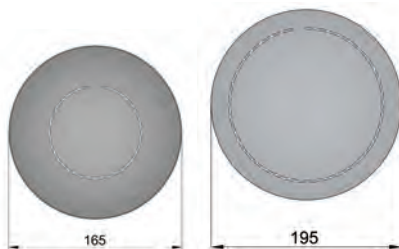

schwarz/noir/black

21.06.157.0 Ø 120 mm

21.06.158.0 Ø 150 mm

grau/gris/grey

21.06.257.0 Ø 120 mm

21.06.258.0 Ø 150 mm

Rosette
mit Schrauben für Beton

Rosette a vis
pour le béton



schwarz/noir/black

21.06.179.0 Ø 150 mm

grau/gris/grey

21.06.279.0 Ø 150 mm

Ofenklappe aus Eisen
clapet en fer



21.02.800.0 Ø 17 cm

21.02.801.0 Ø 14 cm

21.02.802.0 Ø 12 cm

Rauchrohr aus Stahlblech (Stärke 2mm), senothermlackiert mit geschliffenen Schweißnähten
 flue tubes made of sheet steel (thickness 2mm), senotherm painted with ground weld seams
 Tuyaux & Accessoires (épaisseur 2mm) en noir ou gris laqué senotherm avec point de soudure

Rauchrohr
 Tuyau en tôle d'acier

schwarz/noir/black

21.06.300.0	130 x 250 mm
21.06.301.0	130 x 500 mm
21.06.302.0	130 x 1000 mm
21.06.303.0	200 x 250 mm
21.06.304.0	200 x 500 mm
21.06.306.0	200 x 1000 mm

Rauchrohr mit Kondensring
 Tuyau

schwarz/noir/black

21.06.341.0	130 x 130 mm
21.06.342.0	130 x 500 mm
21.06.348.0	200 x 130 mm
21.06.349.0	200 x 500 mm

Rauchrohr Klappe in Putzdeckel integriert
 Tuyau

schwarz/noir/black

21.06.369.0	130 x 500 mm
21.06.370.0	130 x 1000 mm
21.06.367.0	200 x 500 mm
21.06.368.0	200 x 1000 mm

Rauchrohrbogen
 Angle

schwarz/noir/black

21.06.371.0	11°/130 mm
21.06.372.0	22°/130 mm
21.06.373.0	33°/130 mm
21.06.374.0	11°/200 mm
21.06.375.0	22°/200 mm
21.06.376.0	33°/200 mm

Rauchrohrbogen
 Angle

schwarz/noir/black

21.06.311.0	45°/130 mm
21.06.312.0	90°/130 mm
21.06.313.0	45°/200 mm
21.06.314.0	90°/200 mm

Rauchrohrbogen bei 90° Variante mit Tür
 Angle avec regard

schwarz/noir/black

21.06.315.0	90°/130 mm
21.06.316.0	45°/130 mm
21.06.317.0	90°/200 mm
21.06.318.0	45°/200 mm

T-Stück mit Deckel
 Pièce 'T' avec couvercle

schwarz/noir/black

21.06.343.0	Ø 130 mm
21.06.344.0	Ø 200 mm

Rauchrohrbogen verstellbar 0-90°, mit Tür
 Angle orientable

schwarz/noir/black

21.06.319.0	130 mm
21.06.323.0	200 mm

S-Bogen für Rohr 130 mm
 Coude en "S"

schwarz/noir/black

21.06.345.0	60/130 mm
21.06.346.0	40/130 mm
21.06.347.0	80/130 mm

Rauchrohrset Standard, geschliffen

Tuyau-Set /
affilé

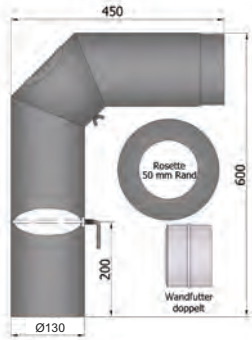

schwarz/noir/black
21.06.321.0 130 mm
21.06.322.0 200 mm

Rauchrohrset Fullform, geschliffen

Tuyau-Set /
affilé

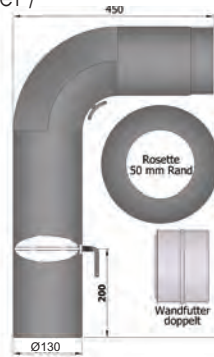

schwarz/noir/black
21.06.320.0 130 mm

Doppelwandfutter mit Mauerlasche und Rosette 5 cm

Mandrin avec rabat de mur
et rosace 5 cm



schwarz/noir/black
21.06.355.0 Ø 130 mm
21.06.354.0 Ø 200 mm

Reduzierung

Reduction

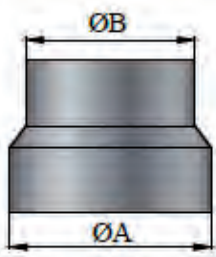

schwarz/noir/black
21.06.330.0 130/120 mm
21.06.331.0 200/150 mm

Erweiterung

Élargissement - rallonge

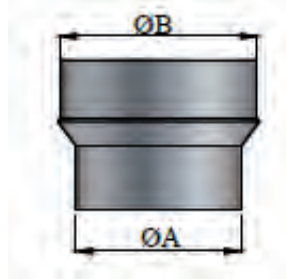

schwarz/noir/black
21.06.328.0 120/130 mm
21.06.329.0 120/150 mm

Mauermuffe doppelt

Manchon de mur double

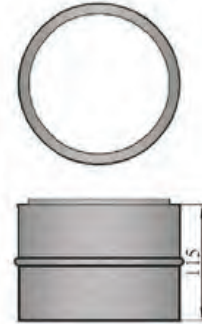

schwarz/noir/black
21.06.339.0 Ø 130 mm
21.06.340.0 Ø 200 mm

Rosette mit Schrauben für Beton

Rosette a vis
pour le béton



schwarz/noir/black
21.06.379.0 Ø 120 mm
21.06.378.0 Ø 200 mm

Deckenrosette
mit Doppelwandfutter

Rosace de plafond avec
mandrin double épaisseur



schwarz/noir/black
21.06.356.0 Ø 130 mm
21.06.357.0 Ø 200 mm

Blinddeckel
für Doppelwandfutter

Couvercle borgne avec mandrin



schwarz/noir/black
21.06.358.0 Ø 130 mm
21.06.359.0 Ø 200 mm



Rosette mit 3 Stiften
Rosace

schwarz/noir/black
21.06.334.0 Rosette 120 mm
21.06.335.0 Rosette 135 mm
21.06.336.0 Rosette 205 mm

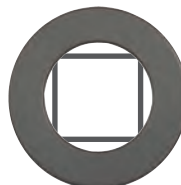

Rosette mit Feder
Rosace avec ressort

schwarz/noir/black
21.06.337.0 Rosette 130 mm
21.06.338.0 Rosette 200 mm

Pellet Rauchrohr

Tuyau pellet en tôle acier

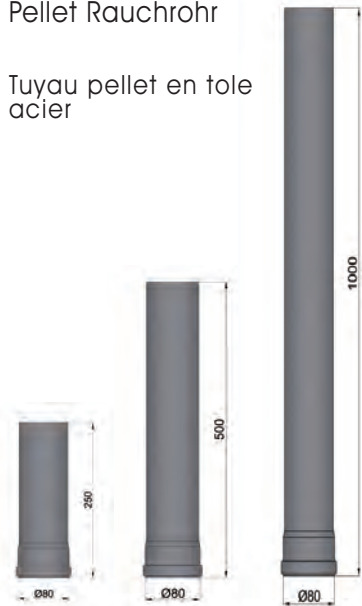

schwarz/noir/black

21.06.400.0	80 x 250 mm
21.06.401.0	100 x 250 mm
21.06.402.0	80 x 500 mm
21.06.403.0	100 x 500 mm
21.06.404.0	80 x 1000 mm
21.06.405.0	100 x 1000 mm

Rauchrohrbogen 2-teilig 45° mit Tür

Angle avec regard

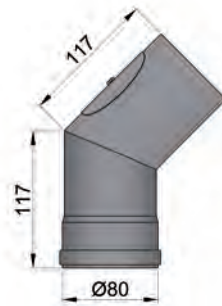

schwarz/noir/black

21.06.406.0	45° / 80 mm
21.06.407.0	45°/100 mm

Rauchrohrbogen 2-teilig, 45°

Angle

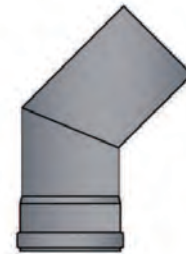

schwarz/noir/black

21.06.430.0	45° / 80 mm
21.06.431.0	45°/100 mm

Rauchrohrbogen 3-teilig 90° mit Tür

Angle avec regard

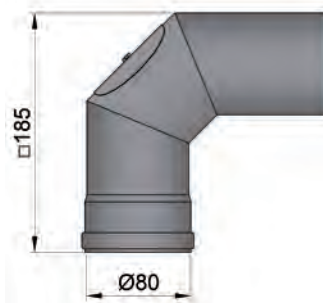

schwarz/noir/black

21.06.408.0	90° / 80 mm
21.06.409.0	90°/100 mm

T-Stück mit Kondenskapsel

T avec capsule à condensation

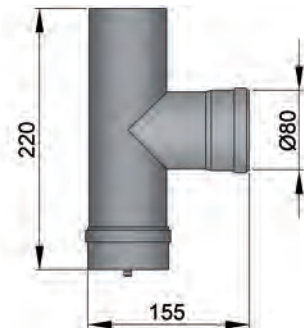

schwarz/noir/black

21.06.420.0	Ø 80 mm
21.06.421.0	Ø 100 mm

Kondenskapsel

Capsule a condensation

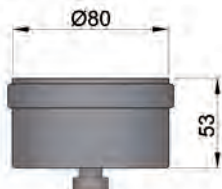

schwarz/noir/black

21.06.424.0	Ø 80 mm
21.06.425.0	Ø 100 mm

Rohrstütze verstellbar

protection pour tuyau amovible

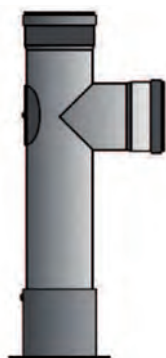

schwarz/noir/black

21.06.435.0	Ø 80 mm
21.06.436.0	Ø 100 mm

Doppelwandfutter

Mandrin

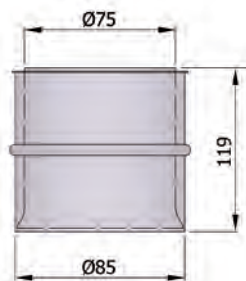

schwarz/noir/black

21.06.422.0	Ø 80 mm
21.06.423.0	Ø 100 mm

Pelletofen Anschluss KIT 100 mm für externe Verbrennungsluftzufuhr

Poêle à pellets Raccord KIT



21.06.445.0	
21.06.446.0	

schwarz/noir/black
grau/gris/grey

Erweiterung
Élargissement - rallonge

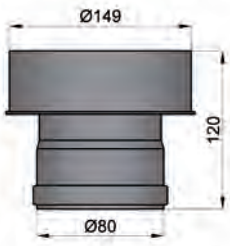

schwarz/noir/black
21.06.410.0 80 / 130 mm
21.06.411.0 80 / 150 mm
21.06.412.0 100 / 130 mm
21.06.413.0 100 / 150 mm

Erweiterung schief
Élargissement - rallonge



schwarz/noir/black
21.06.440.0 80 / 130 mm
21.06.441.0 80 / 150 mm
21.06.442.0 100 / 130 mm
21.06.443.0 100 / 150 mm

Senotherm-Lack 400 ml
Laque senotherm, spray 400 ml



21.06.150.0 schwarz/noir/black
21.06.250.0 gussgrau/gris/grey

Rosette
mit Mauermuffe
Rosace avec manchon de mur

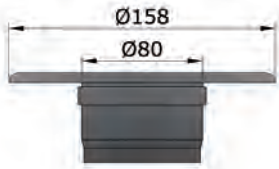

schwarz/noir/black
21.06.426.0 Ø 80 mm
21.06.427.0 Ø 100 mm

Rosette
Rosace



schwarz/noir/black
21.06.437.0 Ø 80 mm
21.06.438.0 Ø 100 mm

Decken-Rosette
Rosace

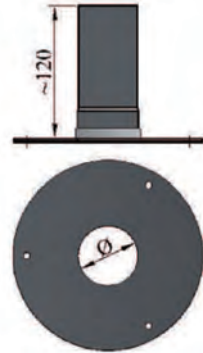

schwarz/noir/black
21.06.432.0 Ø 80 mm
21.06.433.0 Ø 100 mm



Magnetisches Thermometer
für Ofen oder Ofenrohr

Art.-Nr.	Ø	H
60.15.022.0	62	8,5 mm



Schützt den Ofen vor Überhitzung und hilft die Einleitung von Schadstoffen in die Atmosphäre zu reduzieren.

Protects the stove from overheating and helps reduce the discharge of pollutants into the atmosphere.

Thermomètre magnétique pour poêle ou tuyau de poêle. Protège le poêle contre la surchauffe et contribue à réduire le rejet de substances nocives dans l'atmosphère.



Vermiculite ist ein Mineral bestehend aus Aluminiumeisenmagnesiumsilicat, das sich zur Wärmedämmung eignet und außerdem sehr leicht zu bearbeiten ist (schneiden, kleben). Dieses Hochtemperatur-Dämm-Material findet seine Anwendung zum Beispiel bei Kamintüren, Lüftungskanälen, Feuer-schutztüren, Wärmebehandlungsöfen, Gas- und Elektroherden, Heizgeräten, Kühler, Zyklonen, Schiffswänden oder zur Abschottung von Brandabschnitten.

VERMILITE600 Platten haben eine Rohdichte von 600 kg/m³ und sind speziell für den Innenbereich beim Ofen geeignet (Schamottstein - Ersatz).



Vermilite 600
Anwendungstemperatur 1100°C

Art.-Nr.	cm	cm
21.00.800.2	50 x 30	3

VE: 5 Stk.

Schamotteplatte

Plaque d'argile réfractaire

Art.-Nr.	cm	cm
21.00.805.2	25 x 12,4	3



Schamottemörtel / Säurekitt

Mörtel-Dose à 2 kg
(VE = 6 Stück)

Säurekitt à 1 kg

Mortier, boîte de 2 kg
Mastic de 1 kg

Art.-Nr.		
21.00.810.2	Mörtel 2 kg	
21.00.811.2	Säurekitt 1 kg	



Schwarze Paste Bindulin, zum Verschönern und Polieren verschiedenster Oberflächen, hitzebeständige Metallmatierung, Tube à 45 ml

Pâte à polir

Art.-Nr.		
21.00.818.2		



Ofenkitt Froschmarke bis 1000°C hitzebeständig

Mastic pour poêles, résistant à une chaleur de 1000°C, sèche en 5-6 heures

Art.-Nr.		
21.00.812.2	Dose à 500 g	
21.00.813.2	Dose à 1000 g	



Ofenkitt, Kartusche 310 ml bis 1000°C hitzebeständig, Überkarton: 12 Kartuschen

Mastic pour poêles

Art.-Nr.		
21.00.814.2	310 ml	



Feuerzement 2 kg hitzebeständig bis 1000°C VE = 10 Stück

Ciment, résistant à une chaleur de 1000°C

Art.-Nr.		
21.00.815.2	2 kg	



ISO-Glasband schwarz,
selbstklebend, bis 550°C

Bandeau en verre ISO, noir, auto-
collant, sur un côté, maximale
température 550°C

Art.-Nr.		Länge
21.06.511.0	10 x 2 mm	25 m
21.06.512.0	20 x 2 mm	25 m



ISO-Glasband schwarz,
selbstklebend, bis 550°C

Bandeau en verre ISO, noir, auto-
collant, sur un côté, maximale
température 550°C

Art.-Nr.		Länge
21.06.511.7	10 x 2 mm	2 m
21.06.512.7	20 x 2 mm	1 m



ISO-Glasband weiß,
selbstklebend, bis 550°C

Bandeau en verre ISO, blanc,
autocollant, sur un côté, maxi-
male température 550°C

Art.-Nr.		Länge
21.06.515.0	10 x 2 mm	25 m
21.06.516.0	20 x 2 mm	25 m
21.06.517.0	30 x 2 mm	25 m
21.06.518.0	40 x 2 mm	25 m
21.06.519.0	50 x 2 mm	25 m



ISOGLAS Strickgeflecht anthrazit
bis 500°C

Lacis en verre ISO

Art.-Nr.	Ø	Länge
21.06.500.0	6 mm	25 m
21.06.501.0	8 mm	25 m
21.06.502.0	10 mm	25 m
21.06.503.0	12 mm	25 m
21.06.504.0	15 mm	25 m
21.06.505.0	18 mm	25 m



ISOGLAS Strickgeflecht anthrazit
bis 500°C, inkl. Kleber

Lacis en verre ISO, anthracite, maxi
température 500°C, avec colle

Art.-Nr.	Ø	Länge
21.06.500.7	6 mm	2 m
21.06.501.7	8 mm	2 m
21.06.502.7	10 mm	2 m
21.06.503.7	12 mm	2 m



Kleber für Dichtschnüre bis 1100°C
Tube à 17 ml, Karton 50 Tuben

Colle pour joint, résistante aux temp.
élevées de 1100°C, tube de 17 ml

Art.-Nr.	
21.06.520.0	17 ml



Ofenrohrwischer

Brosse métallique
pour tuyau de poêle

Art.-Nr.	
21.00.820.2	Ø 13 cm, mit Stiel 1,2 m
21.00.821.2	Ø 16 cm, mit Stiel 2 m



Ofenkesseldrahtbürste
Stahldraht

Brosse métallique pour chaudières
de four. Fil d'acier

Art.-Nr.	
21.00.822.2	Ø 7 cm, mit Stiel 0,6 m
21.00.823.2	Ø 12 cm, mit Stiel 0,5 m



Kamintüre verzinkt,
mit Hebelverschluss

Porte de cheminée
zinguée, fermeture à levier

Art.-Nr.	cm	cm
21.00.825.2	22,5	28,5
Türmaß:	17	23



Wasserverdunster-Set
aus Edelstahl, rund
für Flach- und Rippen-
heizkörper, 2er Set mit
Aufhängehaken

Saturateur rond inox,
pour tous radiateurs
par 2 avec crochets inclus

Art.-Nr.	cm	cm
21.00.407.0	∅ 5	20,5



Wasserverdunster-Set
aus Edelstahl,
halbrund für Flach-
heizkörper, 2er Set
mit Aufhängehaken

Saturateur en inox mi rond
par 2 avec
crochets inclus

Art.-Nr.	cm	cm
21.00.406.0	8 x 3,2	20



Wasserverdunster-Set
aus Glas, rund für Flach-
und Rippenheizkörper
2er Set mit Aufhängehaken

Saturateur
en verre
par 2 avec crochets inclus

Art.-Nr.	cm	cm
21.00.409.0	∅ 5	20,5



Wasserverdunster
aus Edelstahl,
zum Aufstellen

Saturateur
en inox, a poser

Art.-Nr.	cm	cm
21.00.408.0	23 x 7,5	6,7



Wasserverdunster Gr. 1
für den Heizkörper, Kunst-
stoff weiß, inkl. Haken,
mit Vlies für stärkere Ver-
dunstung

Saturateur Taille 1
saturateur plastique
avec réservoir,
crochets inclus

Art.-Nr.	cm	cm
21.00.410.0	27,5 x 5	31,5



Wasserverdunster Gr. 2
für den Heizkörper, Kunst-
stoff weiß, inkl. Haken,
mit Vlies für stärkere Ver-
dunstung

Saturateur Taille 2
saturateur plastique
avec réservoir,
crochets inclus

Art.-Nr.	cm	cm
21.00.411.0	17 x 5	31,5



Vlieseinlagen zu
Wasserverdunstern

A) 21.00.410.0

5 Stück Gr. 1

B) 21.00.411.0

5 Stück Gr. 2

Recharge pour
saturateur
A) set de 5 pcs.
Taille 1
B) et de 5 pcs.
Taille 2



Art.-Nr.	cm	cm
A) 21.00.410.1	24,5	29
B) 21.00.411.1	14,5	29

Design-Schale, Edelstahl matt
gebürstet, doppelwandig, hitze-
beständig

coupe en inox
brossé mat,
double épaisseur,
résistante à la chaleur



Art.-Nr.	cm	cm
20.03.960.0	∅ 33	8,9 cm
20.03.950.0	∅ 36	8 cm

Wasserverdunster
Keramik weiß mit Relief
für Flachheizkörper
inkl. Aufhängehaken

Saturateur
céramique blanc avec
relief, pour radiateur plat
crochet de
suspension inclus

Art.-Nr.	cm	cm
21.00.401.0	8,2 x 4	19,8



Wasserverdunster
Keramik weiß
für Flachheizkörper
inkl. Aufhängehaken

Saturateur
céramique blanc lisse,
pour radiateur plat,
crochet de
suspension inclus

Art.-Nr.	cm	cm
21.00.402.0	8,2 x 4	19,8



Wasserverdunster
Keramik weiß
mit 2 Einfüllöffnungen

Saturateur
céramique blanc,
2 orifices de remplissage

Art.-Nr.	cm	cm
21.00.400.0	25 x 9,7	4,5

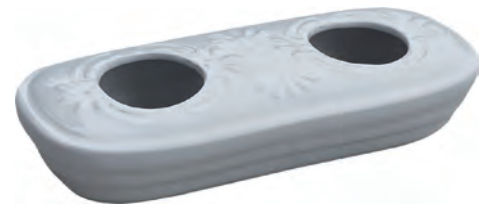

Wasserverdunster
Keramik weiß mit Relief
für Rippenheizkörper
inkl. Aufhängehaken

Saturateur
céramique blanc
avec relief, crochet
de suspension inclus

Art.-Nr.	cm	cm
21.00.404.0	8 x 4,5	20,7



Wasserverdunster
Keramik weiß,
für Rippenheizkörper
inkl. Aufhängehaken

Saturateur
céramique blanc,
crochet de
suspension inclus

Art.-Nr.	cm	cm
21.00.405.0	8 x 4,5	20,7



Wasserverdunster
Keramik mit Relief
für Flachheizkörper
inkl. Aufhängehaken

Saturateur
céramique avec relief, pour
radiateur plat, crochet de
suspension inclus

Art.-Nr.	cm	cm
21.00.403.0	10,5 x 4,5	20,5



Grillspieße Edelstahl 1 4301 elektropoliert,
mit Buchengriffen, mit abschraubbarer Spitze

Barbecu skewers SS14301 electropolished,
beech wood handle L. 89cm

Broches à barbecue Acier inoxydable 1 4301 électropoli,
avec poignées en hêtre, avec pointe dévissable

Art.-Nr. Spieß einzeln	Länge
21.05.060.0	89 cm



Set: bestehend aus 5 Spießern
und einer Aufbewahrungsbox aus Holz

Set : composé de 5 brochetteset une boîte de rangement en bois

Art.-Nr.
21.05.061.0



Grillrost
Edelstahl matt gebürstet, inkl. 2 Griffe

Stainless steel grill with 2 Handles

Grille de cuisson Acier inoxydable brossé mat, 2 poignées incluses

Art.-Nr.	cm	cm
21.02.810.0	21 x 27	12
21.02.811.0	28 x 27	12
21.02.812.0	35 x 27	12



Blasebalg aus Holz, Kunstleder, edelstahlfärbig

Bellows made of wood and imitation leather

Soufflet en bois et similicuir

Art.-Nr.	cm	cm
21.02.719.2	16	38



Einheiz- und Grillhandschuh geprüft

Barbecue gloves

Gant de chauffage et de barbecue, testé

Art.-Nr.	cm	cm
21.06.062.0	17 cm	27 cm



Original Feuerbällchen

Natürliche Anzünder für Kamin,
Kachelöfen & Grillen

- Brenntemperatur bis zu 530°
- ca. 10 Minuten Brenndauer
- Naturmaterial (Wachs und Holz)
- Sparsamer Verbrauch
- Unbeschränkte Haltbarkeit

Lighters for fireplace and barbecue
- combustion time: 10 minutes
- natural material (wood and wax)

Allumé cheminée et barbecue naturels
- durée de combustion: 10 minutes
- composition naturelle (cire et bois)
- sans odeur ni résidu



1 kg im Karton (ca. 80 Anzünder)

Art.-Nr.

21.06.045.0

Überkarton = 18 Pkg.

1 Display = 36 Pkg.



1 Überkarton = 18 Kartons

1 Palette = 180 Kartons
(10 Überkartons à 18 Pkg.)



1/4 Palettendisplay

1 Überkarton = 18 Kartons á 1kg

2 Überkarton = 36 Kartons á 1kg *)

*) Lieferung im Verkaufsdisplay mögl.

Art.-Nr. Display 1/4-Palette 21.06.046.0

4 Überkarton = 72 Kartons á 1kg **)

***) Lieferung im Verkaufsdisplay mögl.

Art.-Nr. Display 1/2-Palette 21.06.047.0

*) und **) sind Artikelnummern für leere Displays



Anzündler für Kamin, Kachelofen und Grill

Lighters for fireplace and barbecue
Allumé cheminée et barbecue

Art.-Nr.	Stk./Pcs.	kg
21.06.048.0 250 g im Polybeutel	ca. 20	0,25
21.06.051.0* 2 kg im PVC-Sack	ca. 160	2

*) 54 Säcke/sacs = 1/2 Palette (VK-Display)
108 Säcke/sacs = 1 Palette



Anzündler für Kamin, Kachelofen und Grill

Lighters for fireplace and barbecue
Allumé cheminée et barbecue

Art.-Nr.	Stk./Pcs.	kg
21.06.043.0 1 kg im Papiersack	ca. 80	1 kg

*) 96 Säcke/sacs = 1/2 Palette (VK-Display)
192 Säcke/sacs = 1 Palette



Anzündler für Kamin, Kachelofen und Grill

Lighters for fireplace and barbecue
Allumé cheminée et barbecue

Art.-Nr.	Stk./Pcs.	kg
21.06.054.0 2,5 kg im Papiersack	ca. 200	2,5

*) 40 Säcke/sacs = 1/2 Palette (VK-Display)
80 Säcke/sacs = 1 Palette



Anzündler für Kamin, Kachelofen und Grill

Lighters for fireplace and barbecue
Allumé cheminée et barbecue

Art.-Nr.	Stk./Pcs.	kg
21.06.049.0* 4 kg im Papiersack	ca. 320	4
21.06.041.0 12,5 kg im Papiersack	ca. 1000	12,5

*) 80 Säcke/sacs = 1 Palette

Bio-Ethanol 99%
hochreiner Alkohol zur Benutzung
in Ethanol-Kaminen und
speziellen Feuerstellen 1000 ml
VE 12 Stk

Bio-ethanol, 99%
high purity
alcohol for use in
ethanol fireplaces
and stoves
1000 ml bottle

éthanol bio
1000 ml

Art.-Nr.

21.06.088.0



Bio-Ethanol 99%
hochreiner Alkohol zur Benutzung in
Ethanol-Kaminen und speziellen
Feuerstellen, 5000 ml

Bio-ethanol, 99%
high purity
alcohol for use
in ethanol
fireplaces and
stoves
5000 ml tank

éthanol bio
5000 ml

Art.-Nr.

21.06.602.0



Kohleanzünder, Basis Kerosin,
schnell, intensiv, brennstark
32 Stk./Pkg., 24 Pkg./Karton

coal lighter,
based of Kerosene

Allume charbon sur base
de kérosène

Art.-Nr.

21.06.030.0



Kohleanzünder, Basis Kerosin,
schnell, intensiv, brennstark
64 Stk./Pkg., 12 Pkg./Karton

coal lighter,
based of Kerosene

Allume charbon sur base
de kérosène

Art.-Nr.

21.06.031.0



Grill- und Kamin-Anzünder
Basis N-Paraffin,
100 Stk./Pkg.

grill and fireplace lighter,
based of N-Paraffin

Allume feu pour
grill et Cheminée,
sur base de N-paraffine

Art.-Nr.

21.06.604.0



Sparbrenner für Ölofen

anti-soot spiral for oil stoves
economiseur pour poêle à mazout

Art.-Nr.

21.06.075.0 schwarz



Zündhölzer

L= 200 mm - 55 Stk/Pkg (55 pc./boite)
L= 100 mm - 55 Stk/Pkg (55 pc./boite)

matches / allumettes

Art.-Nr.

VE

21.06.072.0 Länge 200 mm 10
21.06.073.0 Länge 100 mm 20



Firemizer

Matte aus speziellen, extrem wärmeleitenden Metallfasern für effektiven Abbrand von Holz und Kohle

Suitable for open fireplaces and all wood and coal stoves

Tapis en fibres métalliques pour une combustion efficace du bois

Art.-Nr.

21.06.470.0 18 x 28 cm



Schnellanzünder mit Reibekopf, 50er Streifen

Igniter for liquid stoves, f.e. oil
Allume-feu, 50 pièces

Art.-Nr.

VE

21.06.077.0 Anzünder 24



Schornstein reinigendes Scheit mit Prüfzeichen, 100 % Naturprodukt, verringert den Brennstoffverbrauch

chimney-cleaning log with test mark

bûche à nettoyer la cheminée

Art.-Nr.

VE

21.06.063.0 12



Woodmiser

2 Matten aus speziellen, extrem wärmeleitenden Metallfasern für effektiven Abbrand von Holz und Kohle

Suitable for open fireplaces and all wood and coal stoves

Tapis en fibres métalliques pour une combustion efficace du bois

Art.-Nr.

21.06.471.0 14 x 28 cm



Kaminscheiben Schaumreiniger

- Hochleistungs-Aktivschaum-
Reiniger zur rückstands-
freien Beseitigung
hartnäckigster Ver-
schmutzung wie z.B.
Ruß, Fett, Öl, uvm.
- für Kachelofen- und
Kaminglas
- hochergiebig
- stabile Haftung durch
Aktivschaum
- selbsttätige Wirkung

fireplace window foam
cleaner

mousse à nettoyer les
vitres d insert



Art.-Nr.	Inhalt	VE
21.06.080.0	300 ml	12

Kaminscheiben- reiniger flüssig

- kraftvoller Schmutzlöser
für mühelose Reinigung
von verußtem
Kachelofen-
und Kaminglas
- wirkt schnell und
gründlich
- sehr ergiebig
- langwirkend

fireplace window cleaner,
liquid

liquide à nettoyer
le carreau



Art.-Nr.	Inhalt	VE
21.06.081.0	500 ml	24

Natur- und Specksteinofen- Reiniger

- tiefenwirksamer Spezial-
reiniger für Natur-
und Specksteinöfen
sowie Arbeitsplatten,
Böden und Verkleid-
ungen aus Naturstein
- entfernt mühelos
Kaffee-, Tee- Kakao-,
Fett, Ruß und Asche-
flecken sowie hart-
näckige organische
Verschmutzungen

detergent for natural
stone stoves

détergent pour stéatite



Art.-Nr.	Inhalt	VE
21.06.082.0	500 ml	24

Natur- und Specksteinofen- Pflege

- hochwertiges Schutz-
und Pflegemittel für
offenporige Natur- und
Specksteinoberflächen
- ideal zur Anwendung
nach der Behandlung
mit dem Natur- u. Speck-
steinofen-Reiniger
- frischt matte abgenutzte
Stellen auf und beseitigt
feine Kratzer
- auch zur Entfernung von
Kerzenwachs geeignet

detergent for natural
stoves

détertif pour stéatite



Art.-Nr.	Inhalt	VE
21.06.083.0	500 ml	24

Natur- und Specksteinofen- Pflegeset

- 500 ml Reiniger + 500 ml Pflege
21.06.082.0 & 21.06.083.0

Set de détergent
21.06.082.0
et détersif
21.06.083.0



Art.-Nr.	Inhalt	VE
21.06.084.0	2x 500 ml	2x 1

Spezial-Reinigungsschwamm

Perfekte Trocken- oder Naßreinigung
für alle Kaminscheiben, Garantiert
kratzfrei (ipi-geprüft). 2er Packung,
32 Pkg. / Karton

Special cleaning sponges for stoves
or fireplace windows

éponge pour vitre d insert



Art.-Nr.
21.06.042.0



KAM iN ZUBE HÖR



LIENBACHER



LIENBACHER

1. Angebote

Angebote werden kostenlos abgegeben und sind nur für eine angemessene Frist und bei Abnahme der angegebenen Menge gültig und freibleibend. Auf überlassene Zeichnungen und Unterlagen behalten wir uns das Eigentums- und Urheberrecht vor, außerdem dürfen Unterlagen Dritten ohne unsere ausdrückliche Genehmigung nicht zugänglich gemacht werden.

2. Preise

Alle bisherigen Preislisten, schriftlichen und mündlichen Offerte werden mit Inkrafttreten dieser Preisliste ungültig. Alle unsere Preise sind unverbindlich. Preisänderungen als Folge von Material- bzw. Lohnkostensteigerungen können jederzeit, auch ohne vorherige Benachrichtigung, vorgenommen werden.

3. Lieferung

Jeder Versand erfolgt auf eigene Gefahr und Rechnung des Bestellers, auf die von uns bestimmte Versandart.

Lieferungen in Deutschland ab einem Netto-Fakturenwert von Euro 250.– erfolgen franko Bestimmungsort. Für Sendungen unter diesem Warenwert erfolgen die Lieferungen unfrei (ab Werk). Gewünschte Expresß- oder Eilsendungen gehen zu Lasten des Bestellers. Abrufaufträge gelten längstens 1 Jahr ab Bestelldatum. Nach Ablauf dieser Frist sind wir berechtigt, die noch nicht abgerufene Ware an den Käufer abzusenden und zu fakturieren.

4. Retourwaren

Rücksendungen dürfen nur mit unserem Einverständnis, ohne Nachnahme und nur bei einwandfreiem Zustand der Ware und der Verpackung erfolgen. Bei Verschulden des Kunden werden für uns anfallende Transportkosten sowie entsprechend angemessene Manipulationskosten verrechnet bzw. vom Guthriftsbetrag abgezogen.

Sonderanfertigungen und separate Bestellungen können nicht zurückgenommen werden.

5. Beanstandungen

Reklamationen müssen innerhalb von 8 Tagen nach Warenübernahme schriftlich erfolgen. Wandlungs- und Minderungsansprüche sowie das Recht zum einseitigen Vertragsrücktritt seitens des Käufers sind ausgeschlossen.

6. Eigentumsvorbehalt

Unsere Lieferungen bleiben bis zur restlosen Bezahlung unser uneingeschränktes Eigentum. Im Fall der Weiterveräußerung treten Sie Ihre Forderungen gegenüber Ihrem Abnehmer an uns ab.

7. Zahlung

Unsere Rechnungen sind innerhalb von 10 Tagen ab Rechnungsdatum mit 2% Skonto oder innerhalb von 30 Tagen netto zu begleichen, sofern keine anderen Vereinbarungen getroffen wurden. Bei Überschreiten des Zahlungstermins werden bankübliche Verzugszinsen berechnet. Weiters verpflichtet sich der Kunde, im Falle des Zahlungsverzuges alle dem Vertragspartner entstehenden Kosten, Spesen und Barauslagen, aus welchem Titel auch immer sie resultieren und die diesem durch die Verfolgung seiner berechtigten Ansprüche aus diesem Vertragsverhältnis entstehen, insbesondere die tarifmäßigen Kosten der Einschaltung eines konzessionierten Inkassobüros, zu ersetzen.

8. Toleranzen

Die durch die Herstellung bedingten oder der Verbesserung dienenden Abweichungen in Maßen, Inhalten, Gewichten und Farbtönen sind im Rahmen der handelsüblichen bzw. bestehenden Toleranzen sowie nach den Bestimmungen des Maßen- und Gewichtsgesetzes zulässig. Muster, die einer Lieferung zugrunde gelegt werden, gelten als ungefähre Grundlage der Lieferung.

9. Druckfehler

Für Druckfehler in Katalogen und Preislisten übernehmen wir keine Verantwortung. Ebenso sind alle Abbildungen und Maßangaben annähernd und unverbindlich. Zweckdienliche Änderungen behalten wir uns vor.

10. Gerichtsstand

Ried/Innkreis

Notizen

A series of horizontal dotted lines for writing notes, arranged in a regular pattern across the page.



M. Lienbacher GmbH
Weikertsham 17 | A-5163 Palting
Telefon +43(0)6217 8734-0
Fax +43(0)6217 8783 | service@m-lienbacher.at
www.m-lienbacher.at



LIENBACHER